



An Axiometrix Solutions Brand

# imc STUDIO 2024

What is new

Doc. date created: 2024-04-16



© 2024 imc Test & Measurement GmbH

imc Test & Measurement GmbH • Voltastr. 5 • 13355 Berlin • Germany

---

## Disclaimer of liability

The contents of this documentation have been carefully checked for consistency with the hardware and software systems described. Nevertheless, it is impossible to completely rule out inconsistencies, so that we decline to offer any guarantee of total conformity.

We reserve the right to make technical modifications of the systems.

## Copyright

© 2024 imc Test & Measurement GmbH, Germany

This documentation is the intellectual property of imc Test & Measurement GmbH. imc Test & Measurement GmbH reserves all rights to this documentation. The applicable provisions are stipulated in the "imc Software License Agreement".

The software described in this document may only be used in accordance with the provisions of the "imc Software License Agreement".

## Open Source Software Licenses

Some components of imc products use software which is licensed under the GNU General Public License (GPL). Details are available in the About dialog.

A list of the open source software licenses for the imc measurement devices is located on the imc STUDIO/imc WAVE/imc STUDIO Monitor installation medium in the folder "*Products\imc DEVICES\OSS*" or "*Products\imc DEVICEcore\OSS*" or "*Products\imc STUDIO\OSS*". If you wish to receive a copy of the GPL sources used, please contact our tech support.

# Table of contents

<b>Update</b> .....	<b>4</b>
<b>Introduction</b> .....	<b>5</b>
<b>imc STUDIO 2024 R1</b> .....	<b>6</b>
1 Firmware and new hardware .....	6
1.1 Firmware imc DEVICES 2.17 R1 .....	6
1.2 Firmware imc DEVICEcore 3.7 R1 .....	7
2 Setup and device control .....	8
3 imc Online FAMOS .....	10
4 Miscellaneous optimization .....	10
<b>Additional missing components and functions belonging to Version 5.2</b> .....	<b>12</b>
<b>Archive</b> .....	<b>13</b>
1 imc STUDIO 2023 .....	13
1.1 Introduction .....	13
1.2 imc STUDIO 2023 R6 .....	13
1.3 imc STUDIO 2023 R5 .....	19
1.4 imc STUDIO 2023 R4 .....	24
1.5 imc STUDIO 2023 R3 .....	34
1.6 imc STUDIO 2023 .....	41
1.7 Update-notes and compatibility from 2022 to 2023 .....	59
2 imc STUDIO 2022 .....	59
2.1 Introduction .....	59
2.2 imc STUDIO 2022 R3 .....	60
2.3 imc STUDIO 2022 R2 .....	69
2.4 imc STUDIO 2022 R1 .....	74
2.5 Update-notes and compatibility from 5.2 to 2022 .....	109
<b>Device overview</b> .....	<b>111</b>

# Update

Along with the PC software imc STUDIO, the software comprises components such as the firmware and devices driver packages imc DEVICEcore and imc DEVICES. With a firmware update, the firmware can be loaded into the system. Please check regularly whether any new software/firmware versions are available and perform an update if your version of imc STUDIO supports the new firmware. Further information can be obtained from our tech support or the imc website.

## Download links:

imc STUDIO <https://www.imc-tm.com/imc-studio/software/>

## imc DEVICEcore and imc DEVICES as a driver package for imc STUDIO

The drivers and firmware components for imc devices are provided in "imc DEVICEcore" and "imc DEVICES". Thus, at least one of the two driver packages is a necessary requirement for operating imc devices under imc STUDIO.

- imc DEVICEcore: For devices belonging to the [firmware group B](#) - e.g. ARGUSfit, EOS
- imc DEVICES: For devices belonging to the [firmware group A](#) - e.g. CRONOS family, C-SERIES, SPARTAN, BUSDAQ

Both packages can be installed and operated in parallel. The software and the devices automatically apply the appropriate package.



### Notes

### Compatibility between imc STUDIO and imc DEVICES

In regard to the use of imc DEVICES as the device driver, there is a clear distinction determining the compatibility of versions/version groups:

imc STUDIO version	assigned firmware / version group	additionally compatible
2022	2.15	2.14
2023	2.16	2.14, 2.15
2024	2.17	2.14, 2.15, 2.16

**For version 2024**, the applicable rule is: the assigned version group and all **predecessor groups going back to 2.14** are compatible with the imc STUDIO-version used.

## Introduction



Developments in imc STUDIO 2024 focused on various aspects. On the following pages, you will find an exact enumeration and description of the changes.

The imc team wishes you total success in accomplishing your measurement tasks with imc STUDIO.

# imc STUDIO 2024 R1

## 1 Firmware and new hardware

This imc STUDIO version has been released along with the following firmware and devices driver packages:

- [Firmware imc DEVICES 2.17 R1](#) 
- [Firmware imc DEVICEcore 3.7 R1](#) 

### 1.1 Firmware imc DEVICES 2.17 R1

Alongside minor bug fixes, the following important improvements have also been implemented:

Area	Description
imc Online FAMOS	The icons within the imc Online FAMOS editor have been updated. They now correspond with the new design of imc DEVICEcore.
imc PROFIBUS Configurator	The installer for the imc PROFIBUS configurator can be executed again.

## 1.2 Firmware imc DEVICecore 3.7 R1

### Hardware

#### 4-channel measurement module for strain gauge, bridge mode and voltage

The B-4 module belonging to the imc ARGUSfit series is a 4-channel measurement amplifier. It can be used in conjunction with an imc ARGUSfit system and is directly docked with its housing.

Individually isolated, configurable differential channels capturing:

- Strain gauges, bridge-mode sensors and potentiometers
- Voltages (25 mV to 10 V)
- Active transducers that require voltage supply



imc ARGUSfit-B-4

#### imc ARGUSfit-B-4 - at a glance

- Per-channel isolated measurement inputs, individual filtering and ADCs
- Software selectable quarter-bridge completion with 120  $\Omega$ , 350  $\Omega$  und 1 k $\Omega$
- Bridge and sensor supply, channel-wise individually configurable
- Bridge mode excitation from 5 V down to 0.5 V
- Sensor supply of voltage-fed transducers up to +15 V
- 40 kHz bandwidth at max. 100 kSps/channel sampling rate
- Graphical configuration wizard to setup strain gauge modes
- Measurement ranges and sampling rates individually selectable (in steps of 1, 2, 5)
- 24-bit digitization, internal processing and data output
- Robust, compact and miniaturized: click mechanism for imc ARGUSfit systems

### Miscellaneous optimization

Alongside minor bug fixes, the following important improvements have also been implemented:

Area	Description
Firmware	If the firmware update was successful, the dialog closes automatically after a few seconds.
CAN-FD	<ul style="list-style-type: none"> <li>• Scaling offset: For configuration of Integer-variables, it is now possible to enter negative offset values.</li> <li>• The message ID can now be entered as a hex number with the suffix "h", e.g. "7FFh". The assistant then displays the converted decimal value. The input in the form of 0x7ff is not supported.</li> <li>• imc ARGUSfit CAN-FD always sent 8 bytes in classic CAN mode. Now the configured amount of data bytes is sent correctly.</li> <li>• The plausibility check now recognizes invalid names with forbidden special characters.</li> </ul>

## 2 Setup and device control



### The strain gauge measurement modes have been updated

The descriptions and illustrations have been revised. The illustrations now show, among other things, what is present in the device and what must be connected externally to the plug.

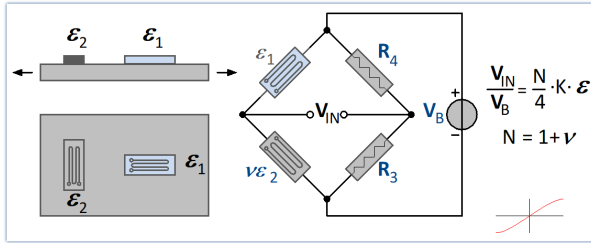

Old graphic for the Poisson half bridge

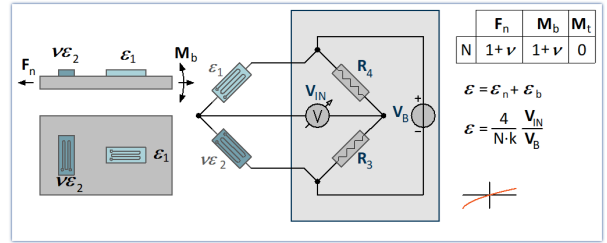

New graphic for the Poisson half bridge



### New strain gauge measurement modes for the new amplifier "ARGFT/B-4"

#### Full bridge - torsion measurement

This bridge circuit uses a full bridge with four active strain gauges, each applied at an angle of 45° to the main axis of the structure. This circuit results in a high sensitivity with good compensation of the temperature influence. It is insensitive to tension or pressure, bending and temperature changes.

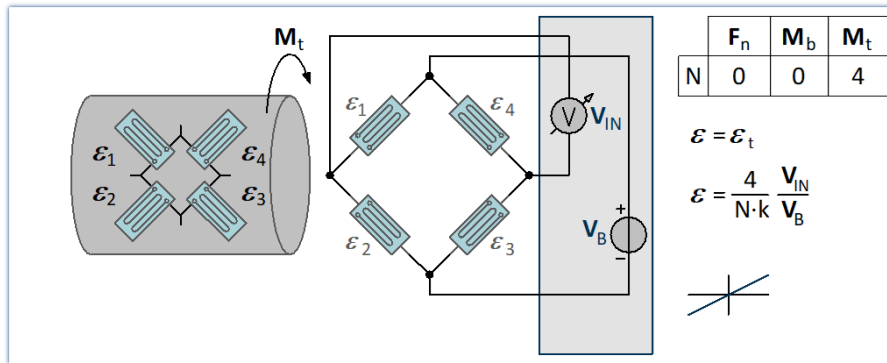

Full bridge - torsion measurement

#### Quarter bridge with external completion resistor

This bridge circuit uses an active strain gauge and an external completion resistor for strain measurement of tension, compression or bending. The strain gauge is located in the uniaxial stress field on the measurement object. This strain gauge is supplemented by two passive resistors in the module (internal supplementary resistors) to form a full bridge.

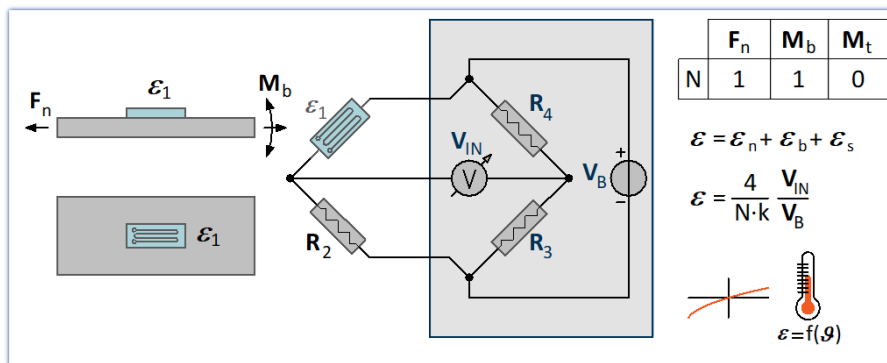

Quarter bridge with external completion resistor



**Diagonal bridge with two strain gauges in uniaxial direction**

This bridge circuit uses two active strain gauges on diagonally opposite sides of the structure to measure strain in tension and compression respectively.

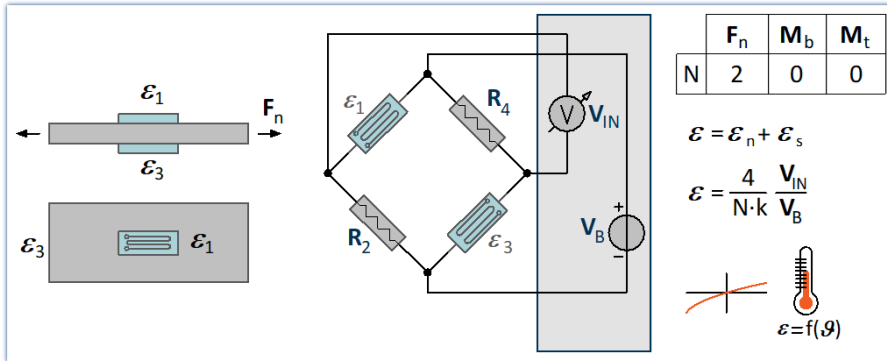

Diagonal bridge with two strain gauges in uniaxial direction

**Diagonal bridge - temperature compensated**

This bridge circuit uses two active strain gauges that are diagonally connected and located on diagonally opposite sides of the structure to measure strain in tension or compression. They are complemented by 2 passive strain gauges, which are mounted on a component made of the same material and at the same temperature to compensate for the influence of temperature.

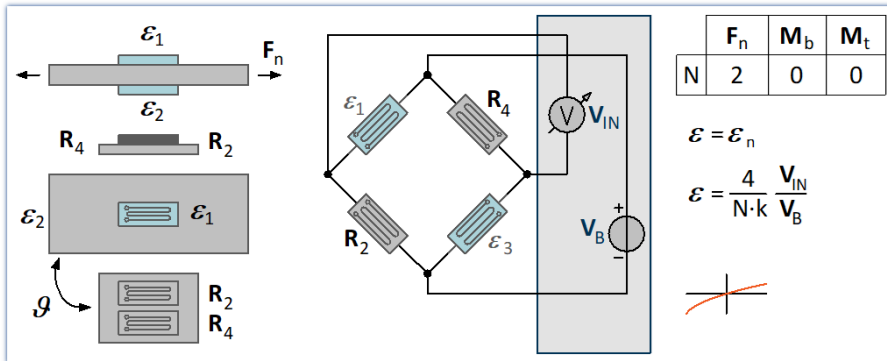

Diagonal bridge - temperature compensated

## 3 imc Online FAMOS



### Target sampling interval instead of a reduction factor

The LEQ and ABCRating functions have been provided with an optional additional parameter.

Instead of specifying a reduction factor, it is possible to specify a target sampling interval. This must be an interval which would result from a permissible integer reduction factor.

### Predefined constants

Predefined constants can now be used in imc Online FAMOS.

Constants	Description
e	Euler number e
InDegr	constant for converting radians to degrees
InRad	constant for converting degrees to radians
PI	circle constant PI
PI2	2 * circle constant PI

## 4 Miscellaneous optimization

Alongside minor bug fixes, the following important improvements have also been implemented:

Area	Description
Device control	<ul style="list-style-type: none"> <li>Name conflicts between devices of different firmware groups are now handled correctly and the measurement can be started correctly once they have been resolved.</li> <li>Reconnection to the current measurement is only possible with imc devices. This no longer results in error messages for third-party devices. Third-party devices can be started individually after reconnection.</li> <li>Improvement in the presentation of the trigger page: The table automatically adjusts to the window width so that longer channel names are better displayed.</li> <li>Improvements in the 4K display The combined columns in the device configuration tables (Setup) are now displayed correctly. Previously, the columns overlapped.</li> </ul>
Data Browser	<p>The expansion behavior in the Data Browser has been improved so that access to the variables is possible in most cases without many actions.</p> <ul style="list-style-type: none"> <li>"Analog channels" in "Current Measurement" is expanded from the start.</li> <li>When searching by name, everything that contains the search result is automatically expanded.</li> </ul>
Metadata	<ul style="list-style-type: none"> <li>The metadata of the DI bits were not saved in the measurement file. The metadata are now saved correctly. The metadata of the ports are an exception. These are not saved in the measurement file. Reason: The port is not saved as a separate file, only the bits.</li> <li>Drop-down list in Data Browser for metadata columns offers new channel metadata directly. Previously, a restart was required.</li> </ul>
Automation	<ul style="list-style-type: none"> <li>It is possible to copy or delete several variables at the same time using multiple selection. In this way, several variables can easily be added.</li> <li>The variable type "Static vector" was limited to 100 values. This limit has now been increased to 100,000 values.</li> </ul>

---

Area	Description
Variables	If the value of a variable was changed on the PC and immediately afterwards on the device via imc Online FAMOS , it could happen that the value change on the device did not arrive on the PC. The displayed value on a widget therefore differed from the actual value on the device.
Transfer to imc FAMOS	During the transfer to imc FAMOS of time-stamped data, there was a crash of imc STUDIO.
Python command	The error behavior has been improved. <ul style="list-style-type: none"><li data-bbox="483 506 1442 566">• If "<i>imcVariables</i>" is specified as an input or output variable, the command returns an error and aborts.</li><li data-bbox="483 577 1453 638">• In the case of an error, the line of the Python script in the sequencer is colored orange (warning) or red (error). As before, the error message appears in the logbook.</li><li data-bbox="483 649 1382 710">• If a variable cannot be transferred to Python or from Python to imc STUDIO, the variable name is also displayed in the error message.</li></ul>
Project management	The export of experiments and projects larger than 2 GB was not working properly.
Licensing	imc STUDIO occupied a imc API network license in some cases.
Installation medium	The installation medium now contains imc FAMOS 2024 R1* and the corresponding curve manager (imc Shared Components). *must be purchased and licensed separately for the PC

---

## Additional missing components and functions belonging to Version 5.2



### Optional components:

- Video

### Individual functions:

- Textual Report channels: The Report channels are deleted from the experiment when it is loaded.
- Data Browser: Deactivation of grouping according to category.
- Data Browser: Check-in and Checkout of measurements in the Data Browser.
- Load measurement settings / Traceability of measurements
- Panel: Navigation Bar
- Deactivation of the component "*imc STUDIO Project Management*"

# Archive

## 1 imc STUDIO 2023

### 1.1 Introduction

Developments in imc STUDIO 2023 focused on various aspects.

- In order to make introduction to the system easier, various changes and enhancements have been implemented. Among others, there is now an assistant for guiding the user through the first steps.
- The display-Widgets automatically adjust to the scale range.
- Various performance problems have been resolved.
- Advances have been made in implementing the GoPro camera.
- The new imc DEVICEcore device series imc ARGUSfit is supported.

On the following pages, you will find an exact enumeration and description of the changes.

In particular, you should read the chapter "[Update-notes and compatibility](#)" before performing the update. It presents all the functional changes and modifications which need to be observed when updating.

The imc team wishes you total success in accomplishing your measurement tasks with imc STUDIO.

### 1.2 imc STUDIO 2023 R6

#### 1.2.1 Firmware and new hardware

This imc STUDIO version has been released along with the following firmware and devices driver packages:

- [Firmware imc DEVICES 2.16 R6](#)
- [Firmware imc DEVICEcore 3.6 R6](#)

##### 1.2.1.1 Firmware imc DEVICES 2.16 R6

Alongside minor bug fixes, the following important improvements have also been implemented:

Area	Description
Miscellaneous	In the version 2023 R5, numerous bugs appeared which had already been fixed in the predecessor versions. The AddOn dated to 19.01.2024 of Version 2023 R5 has fixed these. These problems are no longer present in the current Version 2023 R6 either.

##### 1.2.1.2 Firmware imc DEVICEcore 3.6 R6



#### Diskstart / Autostart

imc EOS and imc ARGUSfit now support automated measurement start after power-on.



#### GPS-channels without synchronization

The GPS-channels of an imc ARGUSfit device are now displayed even when no GPS-synchronization is used.

## Miscellaneous optimization

Alongside minor bug fixes, the following important improvements have also been implemented:

Area	Description
Balancing	<ul style="list-style-type: none"> <li>Taring was not performed when either "Current" or "Resistance" was selected as the measurement mode.</li> <li>Taring caused measurement to start if a measurement had previously been performed.</li> <li>When changes to the device configuration are made during measurement, taring during measurement is no longer possible.</li> </ul>
Measurement	<p>Measurement start of individual channels did not always occur at the relative time reference point X0=0, but sometimes one sample later. The discrepancies occurred when differing sampling rates, especially slow ones (&lt; 100 Hz) were used.</p>
Data saving	<p>When saving a fixed number of measurement points, 1 sample too many was captured.</p>
Trigger	<ul style="list-style-type: none"> <li>Factor-offset-scaling: When the scaling factor was negative, the channel could not be used as the trigger source.</li> <li>Channels on which measurement was stopped by a trigger always had two measurement samples after the stopping event. This means one sample too many. Now stopping occurs correctly after the next sample.</li> <li>When an event occurs before the start of the first measurement, it is ignored if it is no longer in effect. Event monitoring now only begins upon start of the first measurement and no longer directly after preparation of the device. Thus, any events which are no longer prevalent before the first measurement no longer cause data recording to start. Previously, this could happen in the following case: For instance, a threshold violation was detected before the start, then afterward, the measured values are located within the hysteresis band but have not yet fallen below it. This change only applies to the time before the first measurement. For subsequent measurements, the previous behavior is still applicable.</li> </ul>
CAN-FD	<ul style="list-style-type: none"> <li>A variety of improvements of the dialog guidance and of the input options have been made.</li> <li>Optimization of the use of multiple CAN-FD modules: The default name of a log channel is now unique because it includes the device's serial number and its node number.</li> <li>Termination: The software-activated termination now works even when no message at the node is configured.</li> <li>Data in the Motorola format were not sent/received correctly.</li> <li>In Version 2023 R5 a crash could occur when the CAN Assistant was used with the English GUI.</li> </ul>
Scaling factor	<ul style="list-style-type: none"> <li>A valid scaling factor between 0 and 1 was identified as invalid.</li> <li>For configuration of Integer-variables, it is now possible to enter negative scaling factors.</li> </ul>
DBC import	<ul style="list-style-type: none"> <li>DBC-import: The Baud rate from the file was not applied.</li> <li>Units having special characters such as °C, µm, ... are now imported correctly.</li> <li>Channels having the formats Signed and Unsigned Integer had been imported as Real numbers.</li> <li>Some DBC files had previously not been imported.</li> </ul>

Area	Description
Setup	The columns "Manufacturer" and "Device-Firmware" were empty for devices of the firmware-group B.
Hardware	CANFT/T-10-T The measurement mode of CANFT/T-10-T channels was set by default to "Type K". However only "Type T" is possible. The default setting has been corrected.
Connection	When connection with an imc DEVICecore device could not be established because there was an active connection to a different PC, no message appeared in the logbook.
imc Online FAMOS	<ul style="list-style-type: none"> <li>The scaling functions <a href="#">RangeMin/RangeMax</a> always returned 0.</li> <li>The handling of Japanese characters has been improved.</li> </ul>
Data sharing	Sharing values among the devices: imc ARGUSfit devices could send values to the Display-variables of imc devices belonging to firmware group A (e.g. imc CRONOS, imc C-SERIES, ...). Previously, this was only possible for the channel type "Analog inputs". Now the values of other channel types can also be transmitted: including Monitor channels, Fieldbus channels (CAN), virtual (equidistant) channels from imc Online FAMOS.

## 1.2.2 imc Online FAMOS



### Target sampling interval instead of a reduction factor

Certain functions which have a reduction factor as a parameter have been provided with an optional additional parameter.

Instead of specifying a reduction factor, it is possible to specify a target sampling interval. This must be an interval which would result from a permissible integer reduction factor.

Implemented for the following functions: Red, Max, Min, Mean, RMS, StDev, NumberOfPulses, HighLowRatio, Sum, Sum2, ExpoRMS, PulseDuration, PulseFrequency, PulsePhase

### 1.2.3 Metadata



#### Comments on the measurement (Metadata)

By using the Comment-function, it is possible to save explanatory information along with the measurement.

The metadata are saved in parallel with the saved measurement data in the same measurement folder. By default, a multi-line comment box is available for this purpose. Additional metadata (texts, numbers) can be added.

Display of the metadata in a dialog can be specified to occur either before or following the measurement. Optionally, the data can be made available in the form of variables. This makes it also possible to display the data on a Panel page, on which the values can also be edited.

The file's format is the user's choice between a text file and imc-format.

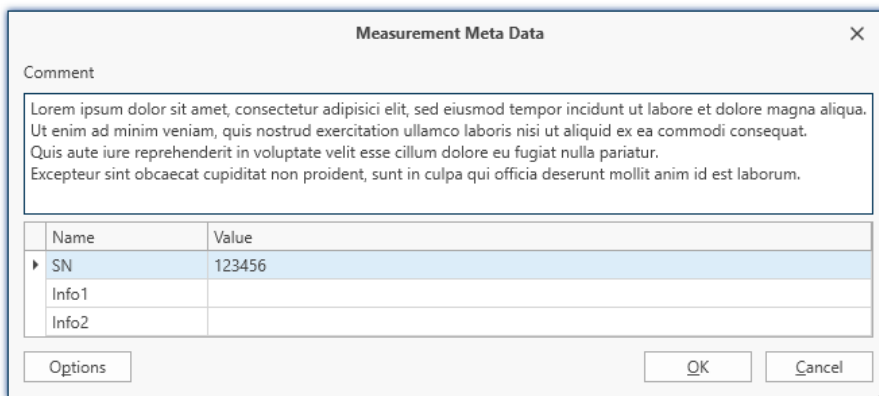

Example of entering metadata on a measurement

#### Notes on compatibility:

This replaces the Metadata-Assistant in imc STUDIO 5.2.



#### Saving metadata to the channel (device)

For devices of firmware group A: The channel-metadata are now saved with the channels also when saving to the device.

#### Display of metadata

**Data Browser:** The metadata saved with the channel can now again be inserted as a column in the Data Browser.

**Placeholder:** Using the placeholder "`<VARS.PROPS>`", metadata saved with the channel can be displayed again.



## 1.2.4 Exporting variables



### Uniform export templates (\*.aet) with imc FAMOS

The export templates of imc FAMOS and imc STUDIO have been grouped. Only one uniform storage location is used for the export templates. It is located at the location defined by imc FAMOS: "C:\ProgramData\imc\Common\Def"

The names have been standardized and the selection has been modified and limited. The ASCII export-templates are no longer offered.

Previously offered by imc STUDIO	New choice
ASCII-Exportvorlage (.asc)	---
ASCII-template_commonScaling (.asc) ASCII-Exportvorlage_gemeinsameSkalierung (.asc)	---
Combined scaling (.csv)	CSV, common scaling
Separated scaling (.csv)	CSV, individual scaling
XLS-Exportvorlage (.xls)	XLSX, individual scaling
XLS-template_commonScaling (.xls) XLS-Exportvorlage_gemeinsameSkalierung (.xls)	XLSX, common scaling

The export format has been revised in order to match the international standard:

- The CSV-format uses the period dot as the decimal separator and the comma as the column separator.
- The Excel-templates use XLSX as the default format.

Note: With the help of imc FAMOS, you can create your own export format templates (\*.aet) and use them in imc STUDIO. The use of one's own templates is also possible on other PCs. No imc FAMOS installation is required. For information on this topic, see the imc FAMOS user's manual.

#### Compatibility notes:

To ensure that existing experiments continue to be functional, the old export templates must be available in the new folder. Upon loading an experiment the system checks whether any templates are missing in the old path. If so, they are copied. Thus, no additional actions are initially necessary.

In this context, note the following:

- The available choices for the format are then both the new choices and the copied ones.
- The old ones do not exist on the PC.

When existing experiments are used on new PCs, export is not possible because the old aet-file does not exist there. A warning appears when the experiment is loaded. You can either make the old templates available on the new PC, or modify the export commands in the experiments to use the new templates.

Please ensure that subsequent programs are able to process the new format if the results files are to be used going forward.



### Exporting variables in text format

The function "Export variables" now offers the ability to export variables as a txt-file. The file contains the variable's name and its current value.

In this way, even user-defined text variables can be exported.

## 1.2.5 Miscellaneous optimization

Alongside minor bug fixes, the following important improvements have also been implemented:

Area	Description
Metadata	The saving of channel metadata is now ensured. In some cases, they had not been saved once an experiment was loaded, if no changes were made.
IEPE-calibration	Reduction of choice of channels: The dialog for IEPE-calibration now has a clearer overview since the only channels offered are ones for which it makes sense to perform calibration. <ul style="list-style-type: none"><li>• The sampling rate must be greater than or equal to 1 kHz.</li><li>• The channel type and coupling specified must match (e.g "AC", "DC", "IEPE",...).</li></ul>
Bus Decoder	Fieldbus-bits caused an error message in the Bus Decoder: "OBD_DataSink::CreateBusfilterSink(): m_pBusfilterSink != NULL Bus Decoder".
Automation	imc FAMOS Data cutting <ul style="list-style-type: none"><li>• When starting the measurement following changes to the Automation, the following error occasionally was returned: "<i>DataWriter-Fehler! &lt;...&gt; The file already exists. Code= 0</i>" This error now no longer appears since the data have been released correctly.</li></ul>
Placeholder VARS.PROPS	The list of available variable properties has been reduced. Only such properties are displayed which the variable actually possesses. If the variable doesn't exist, all properties are displayed.
Installation	When starting the version 2023 R5, in some cases the following error message was posted: " <i>Unable to read the application name from the Registry. ...</i> ". This error is fixed in the current version.
Silent-Installation	The ini-file for silent installation of imc DEVICEcore has been modified. The configuration entered in the ini-file was not used. Additionally, the name was not adapted.
readme	The Products list now also includes " <i>imc Shared Components</i> " along with their associated version numbers.

## 1.3 imc STUDIO 2023 R5

### 1.3.1 Firmware and new hardware

This imc STUDIO version has been released along with the following firmware and devices driver packages:

- [Firmware imc DEVICES 2.16 R5](#) <sup>19</sup>
- [Firmware imc DEVICEcore 3.6 R5](#) <sup>19</sup>

#### 1.3.1.1 Firmware imc DEVICES 2.16 R5

Alongside minor bug fixes, the following important improvements have also been implemented:

Area	Description
imc REMOTE SecureAccess	imc REMOTE SecureAccess has been removed from the dialog "Device search via IP/DNS", as well as from the device properties. The obsolete TLS 1.0 technology is no longer used.

#### 1.3.1.2 Firmware imc DEVICEcore 3.6 R5



##### Envelope type monitor channel for imc ARGUSfit

imc ARGUSfit devices can now generate **reduced envelope type** monitor channels (min-/max-channel). The envelope ensures a complete overview of the measurement and smooth changing of the display even at a high data rate, without burdening the network with an excessive data rate.

The system cyclically condenses **x data points** down to **two new values**: the respective **minimum** and **maximum values** of the x points. The channel's data rate is thus reduced by a factor of  $x/2$ .

This reduced count of values is displayed as an envelope curve. With imc ARGUSfit monitor channels, the factor x can be freely specified in the "preprocessing".

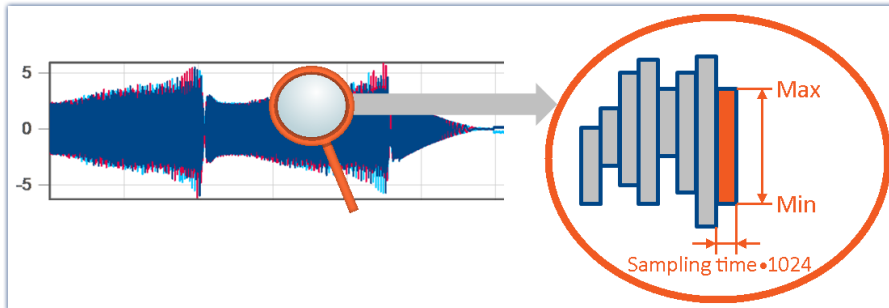

*Envelope type monitor channels  
Example of reduction by 1024 points  
Resulting reduction of the data rate: 512*

Envelope type monitor channels are available on the Setup page: "Analog Inputs" under the channel type: "Monitor Channels". The "preprocessing" must be set to "Envelope".



#### Note

#### Signal processing

The envelope type monitor channels are not suitable for signal processing computations in, for example, imc Online FAMOS/imc Inline FAMOS!



### GPS-synchronization with imc ARGUSfit

imc ARGUSfit devices can now be synchronized via GPS using a connected GPS-mouse. The GPS information is also available in the form of variables if GPS-synchronization is activated. This makes possible the recording of the position and of the GPS quality, among other things, during running measurement.

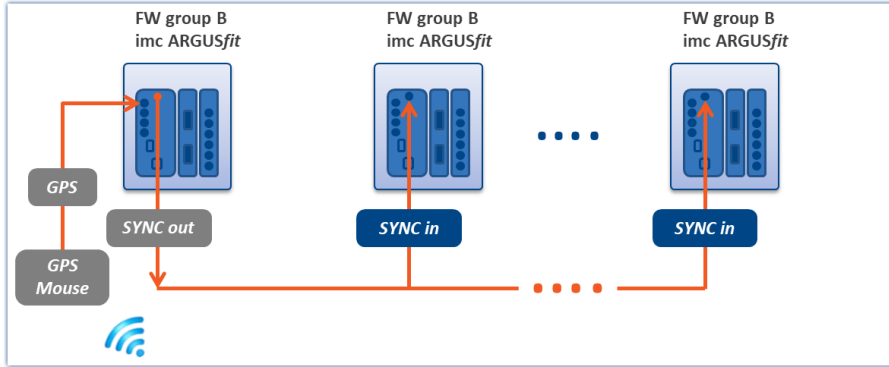

A device synchronized using GPS outputs the time via SYNC-Out / SYNC-In to other devices, so that all clocks are synchronized to each other.



### First use of imc CANSASfit modules on the imc ARGUSfit

It must be ensured that the imc CANSASfit modules are operated with imc CANSAS Software Version 2.3 R1 or higher before use on the imc ARGUSfit.

To do this, the module must be updated with the imc CANSAS software via a USB-CAN interface (e.g. KVASER) or an imc CRONOS/BUSDAQ device.

This procedure is the minimum requirement for connecting these imc CANSASfit modules to an imc ARGUSfit device for the first time. When connected to the imc ARGUSfit, the imc CANSASfit module is updated with the appropriate firmware by imc STUDIO.

Background information:

All imc CANSASfit modules can be operated either connected directly to imc ARGUS, or via the imc CANSAS socket. In order for imc ARGUS to detect the modules, the Baud rate of all imc CANSASfit units must be set to 500 kBaud and the Master/Slave ID must be set to 2/3. As of imc CANSAS Version 2.3 R1, all imc CANSASfit modules are equipped with an automatic mechanism which detects that they are being run by an imc ARGUS unit. The modules then independently make the necessary interface settings.

## Miscellaneous optimization

Alongside minor bug fixes, the following important improvements have also been implemented:

Area	Description
Device configuration	<ul style="list-style-type: none"> <li>The parameters "Filter characteristic" and "Filter Cut-off frequencies" are now hidden whenever they are not in use. In Some cases, "NONE" or "0 Hz" has previously been displayed. This now matches the behavior of the devices belonging to firmware group A.</li> <li>When changing the temperature unit from °C to °F, the conversion was applied to channels which were not set to measure temperature.</li> <li>The respective selection for a temperature measurement, e.g. "PT100", "Type K" ... now appears in the column "Measurement mode".</li> </ul>

Area	Description
Fieldbus channels	<ul style="list-style-type: none"> <li>By means of the Channels table, it was possible to set fieldbus channels to passive (parameter: "Status") but without effect. Now the "Status" is no longer editable for fieldbus channels.</li> <li>It was not possible to set the measurement duration of CAN channels on the Setup page</li> </ul>
Level indicator displays	The level indicator displays (Widget and Channel table) only worked when the metadata were also saved with the channel. Now, the necessary parameters for the overload range are again always included in the transfer.
imc Online FAMOS	From the second device onward, the name of the event-channel in imc Online FAMOS is supplemented with the device's name.
imc ARGUS Base LEDs	The Status- and Storage-LEDs have been modified. The color codes are stated in the imc ARGUSfit manual.
imc EOS	The channel name of an imc EOS device was supplemented with an internal number.

### 1.3.2 Inline Analysis - imc WAVE Noise



#### Sound pressure level under range

Fall of the calculated sound pressure level under range as per the standard: "DIN\_EN\_61672".

In order to determine the level linearity according to the standard, it is important that the under range is observed and evaluated taking into account the measuring range of the input channels. For this purpose, a supplemental variable, "WAVE\_UnderrangeVariable", is available (in parallel) for all existing sound level calculations in a measurement. This variable indicates that a calculated sound pressure level reports under range, but not which calculation.

If an under range is detected, the variable "WAVE\_UnderrangeVariable" is set to "1" at least for one second. After elapse of that one second, the system checks whether any calculation of sound pressure level is still reporting under range.

- If "no", the variable is set back to "0".
- If "yes", the value "1" is retained until the level is no longer under range. Then the variable is set back to "0".

Only such sound pressure level calculations are monitored for under range whose input channels originate from devices belonging to firmware groups A or B (imc DEVICES and imc DEVICEcore).

Sound pressure level calculations whose input channels have no measurement range such as 3rd-party device channels are not monitored.

### 1.3.3 Metadata



#### Saving metadata with the channel - Balancing information

Balancing information can now also be saved with the channel as metadata. The new choice "Balance information" via the option "Setup" > "Traceability of data".

### 1.3.4 Logbuch



#### New function: Export logbook-files

Logbook files are frequently needed by our technical support for error analysis purposes. In response to this button, all existing logbook files are zipped. They can then be sent to our technical support.

### 1.3.5 Miscellaneous optimization

Alongside minor bug fixes, the following important improvements have also been implemented:

Area	Description
Device configuration - Trigger	Channels having long names would usually appear on the Setup page "Trigger" with an abbreviated name due to insufficient room. For this reason it wasn't possible to distinguish between names if the beginning of multiple channel names was the same. The available room is limited. Thus display of the name was modified. If the name doesn't fit in the cell, the beginning and end of the channel's name are shown. The middle part of the name is replaced with dots.
Device configuration - Parameterset import	<ul style="list-style-type: none"> <li>• New mapping: "<i>Uniformly per module type</i>" Set up all channels of a module type uniformly. The assignment is based on module type and channel type (e.g. "ARGFT/UTI-6-SUP", "Analog inputs").</li> <li>• The mappings have been renamed: <ul style="list-style-type: none"> <li>• "<i>Import of channels according to connector and device serial number</i>" → "<i>Multiple-device operation (Firmware group A)</i>"</li> <li>• "<i>Import of channels according to connector</i>" → "<i>Single-device operation (Firmware group A)</i>"</li> </ul> </li> </ul>
Connection to the device	<p>Re-connecting to a running measurement</p> <ul style="list-style-type: none"> <li>• If the pertinent experiment is not found on the PC when re-connecting, the connection procedure is canceled and an error message is posted. Previously in such cases, a prompt appeared to select among various files.</li> <li>• If the project management is deactivated (no database used), the connection can now also be re-established on other PCs on this condition: the experiment and the *.data folder are located on the same path in the PC as the one from which the measurement was started.</li> </ul>
3rd-party device "fos4X"	The channels of an fos4X 3rd-party device do not stop once a defined measurement duration has elapsed. For this reason, it is no longer possible to set a measurement duration for these channels.
Data storage on the PC	An error message was posted when the measurement channel data surpassed 2 GB. Now it is again possible to save volumes of measured data greater than 2 GB to the PC.
imc Online/Inline FAMOS	<p>Function "StDev"</p> <ul style="list-style-type: none"> <li>• If a channel's measurement values fluctuated only within the LSB and thus was not constantly 0, a very small rounding error appeared in the summation of the values. In some cases, this caused a negative number to appear within a square root and to be incalculable in consequence. The replacement value outputted was 1e100.</li> </ul>
Automation	<ul style="list-style-type: none"> <li>• The action "<i>Prepare</i>" for a device with complex automation tasks required very much time and has now been made much faster.</li> <li>• The result of the Data-cutting function was delayed by multiple seconds when slowly sampled channels were cut. The delay became longer as the sampling rate became lower. Now there is no delay in consequence of cutting even with slowly sampled channels.</li> </ul>
Panel	Changes to the option: " <i>Multi-lingual text input</i> " were not saved. Now, the option is deactivated by default and can be activated as needed.

Area	Description
Widgets	<p>Graphical switch</p> <ul style="list-style-type: none"> <li>The graphical switch caused permanent burdening of the CPU.</li> <li>The option "<i>Zoom factor</i>" in the Widget "Graphical switch" was interpreted incorrectly in some regional formats. "0.7" was interpreted as "7".</li> </ul> <p>Table</p> <ul style="list-style-type: none"> <li>Any table on a page which is not open was not displayed upon export of a multi-page PDF-file.</li> </ul> <p>Standard &gt; Switch (Checkbox)</p> <ul style="list-style-type: none"> <li>If the property "<i>Operable</i>" is attached to a variable, the Widget was operable once the experiment had been loaded, even if the variable's value was "0". Now this property is applied correctly upon loading.</li> </ul>
Sequencer	<p>Command "Execute unmanaged DLL"</p> <ul style="list-style-type: none"> <li>When executing the command "<i>Execute unmanaged DLL</i>", an <code>UnhandledException</code> "Constructor not found" occurred.</li> </ul>
Starter-exe	<p>The exe-file of any program (imc STUDIO, imc WAVE, imc STUDIO Monitor) is now located in the respective installation folder and no longer in the folder "<i>ProgramData</i>". Furthermore, the file is provided with a signature.</p> <p>Info on compatibility: Start the imc STUDIO by a shortcut or via the command line, correct the path to the exe-file if appropriate.</p> <ul style="list-style-type: none"> <li>old: "C:\ProgramData\imc\imc STUDIO\Applications\_1\imc STUDIO.exe" "imcDB://DB\StandardProject\MyExperiment"</li> <li>new: "C:\Program Files\imc\imc STUDIO 2023\imc.Studio.exe" "imcDB://DB\StandardProject\MyExperiment"</li> </ul>
Scripting	<p>Newly created event-scripts could not be compiled since the class <code>DeviceStateChangedEventArgs</code> was unknown.</p>
Preview in Windows Explorer	<p>The preview in the Microsoft Explorer is now independent of the default program linked. For this reason, RAW-data are now displayed correctly in the preview, even if RAW is linked with an image processing program.</p>
Experiment/Export project	<p>The <code>imcStudioExport</code>-files are now compressed upon exporting.</p>
Installation	<p>An update installation from one Version 2023 to a newer Version 2023 did not recognize the existing installation if a Version 5.2 was installed in parallel. This caused parallel installation of multiple 2023 versions to occur.</p> <p>As of 2023 R5, any older versions are once again recognized and uninstalled correctly.</p> <p>If you have installed multiple parallel 2023-versions on your PC in this way, then note the following: It is not possible to uninstall the remaining 2023 version(s) once any of the existing 2023 versions has been uninstalled. These will continue to appear in the window "Programs and Functions".</p> <p>This will not cause any loss of functionality.</p> <p>Please contact our Technical Support team if you wish to completely remove the version. Attach the following number: IT041604 to your service request.</p>

## 1.4 imc STUDIO 2023 R4

### 1.4.1 General Changes in imc STUDIO

The new **imc STUDIO 2023 R4** has overcome certain obstacles to greater **performance**. Both **data storage** and the **Automation** have been under exact focus and in consequence the system power has been increased.

Much attention has been devoted to the **new fieldbus assistant** for the imc ARGUS*fit* family of devices. As an enhancement of all imc ARGUS*fit* devices, the new **CAN FD module** is now available.

As well, the first step towards new **metadata handling** has been taken successfully. Saving **metadata in the channel files** is now again possible.

Additionally, **analyses using Python** are now also possible by means of the new command.

### 1.4.2 Performance improvements



#### Saving data with large channel counts

The saving of very many channels to the PC hard drive now no longer puts very high demands on the CPU. Furthermore, a problem has been fixed which had caused a continuous rise in the handle value generated by the data saving.

#### Automation imc FAMOS Data cutting - cutting many channels

The function Automation imc FAMOS Data Cutting made very high demands on the CPU when cutting was performed on a large count of channels.

#### Speedup of first imc FAMOS-command call



Previously, the first run of an imc FAMOS-command after having started imc STUDIO would require significantly more time than subsequent runs. The reason for the delay is that imc FAMOS would be starting at that time. The system waited until imc FAMOS was running in the background. Subsequent calls would proceed quickly once there was no need to restart imc FAMOS.

New behavior: Now when an imc FAMOS-command is created or loaded, imc FAMOS is already opened in the background. Since the program is running in a separate process, there is no delay of imc STUDIO as a consequence. Thus the start occurs at a point in time at which no imc FAMOS analysis is running.



### 1.4.3 Firmware and new hardware

This imc STUDIO version has been released along with the following firmware and devices driver packages:

- [Firmware imc DEVICES 2.16 R4](#) 
- [Firmware imc DEVICEcore 3.6 R4](#) 

#### 1.4.3.1 Firmware imc DEVICES 2.16 R4

Alongside minor bug fixes, the following important improvements have also been implemented:

Area	Description
imc Online FAMOS	Function: <code>OtrFrequLine</code> : The parameter " <i>Period length</i> " was no longer accepted as a decimal number.
CAN-Interface	<ul style="list-style-type: none"> <li>• CAN FD When CAN FD messages were sent in Motorola format, it caused the measurement to crash.</li> <li>• A2L import: "<i>MAXTIX_DIM</i>" is supported.</li> </ul>
Connection to the device	The firmware programs are automatically allowed in the " <i>Windows Defender Firewall</i> " upon installation. For this reason, popup dialogs about the firewall no longer appear upon first connecting to the device.
WFT	The imc Online FAMOS-function <code>RunAutoBalance</code> now also starts the balancing of the WFT-channels both via imc STUDIO, e.g. with a virtual bit, and in Autostart.
Hardware imc SPARTAN BC16	Low passes with a corner frequency < 5 Hz showed an amplitude which was too low.

### 1.4.3.2 Firmware imc DEVICEcore 3.6 R4

#### Hardware



imc ARGUSfit-CAN FD

#### imc ARGUSfit-CAN FD - At a glance

- Two individually galvanically isolated CAN nodes
- CAN FD (max. 8 MBaud), CAN High Speed (max. 1 MBaud), CAN Low Speed (max. 125 KBAud)
- Configurable with new CAN assistant in imc STUDIO
- Decoding of physically and numerically scaled parameters or measuring channels. Such channels can also be used as trigger source, in live analysis (OFA) and in PC-less stand-alone mode
- Logging of the raw, undecoded send and receive data as log channel in imc TSA format (Time Stamped ASCII).
- Log channel can also be decoded outside the interface via imc STUDIO BusDecoder (live) or via imc FAMOS (post-processing), thanks to embedded dbc information
- Support of imc CANSAS modules (CANFX, CANFT) with configuration via dbc file exchange
- Power-via-CAN for supply of imc CANSAS modules by the imc ARGUSfit system: Can be activated by software and with electronic overload protection
- Automated cyclic output of protocol sequences for initialization or activation of sensors and subsystems

#### CAN FD Interface for imc ARGUSfit

The CAN FD interface is a clickable module for the modular imc ARGUSfit system. Together with the analog imc ARGUSfit measurement amplifiers, several of these interfaces can be docked to an imc ARGUSfit base. The ability to acquire CAN-based measurement data and log channels can thus be flexibly added to such a measurement system.

Two CAN nodes are provided at DSUB-9 sockets with standardized pinout. For the logical decoding of the channels, the module has a local intelligence in the form of a processor. This relieves the imc ARGUSfit base unit and the overall system is easily scalable in its total performance even with several interfaces.



## CAN FD - Fieldbus assistant for imc ARGUSfit in the new design

In preparation for all future fieldbus variants, a new assistant has been developed. For all fieldbus variants of the imc ARGUSfit family of devices, a uniform user interface will thus be achieved.

The first fieldbus available is CAN FD. This is configured in the new look.

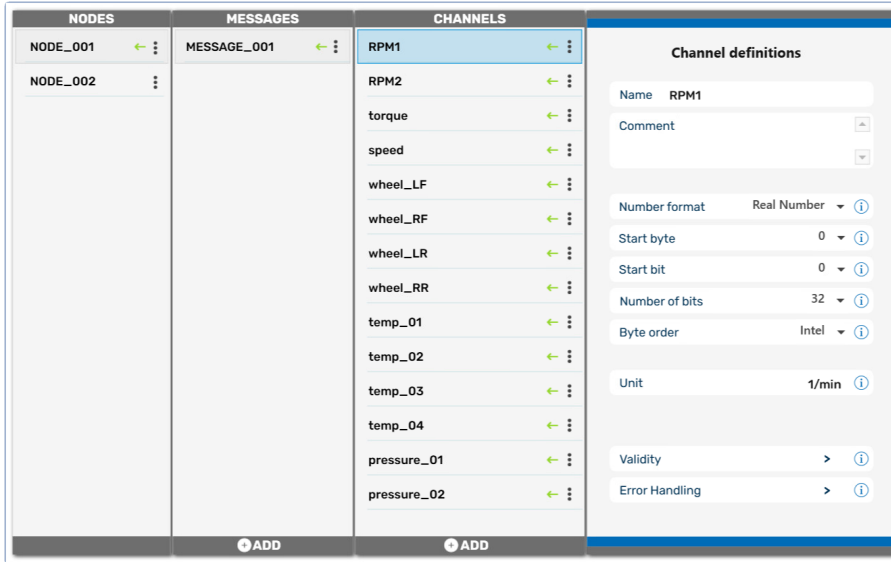

New fieldbus assistant: CAN FD

## Miscellaneous optimization

Alongside minor bug fixes, the following important improvements have also been implemented:

Area	Description
Balancing	When balancing was performed, this was previously only possible during a running measurement. Measurement may have needed to be started for the purpose of balancing. Now, the balancing can also be performed if the measurement is not running. Previously, the action "Prepare" was performed if changes to the configuration were detected.
Transfer configuration	By means of device de-selection, it is possible to transfer an imc ARGUSfit device's configuration to a different imc ARGUSfit device. This happens in the same way as is familiar from firmware group A devices.
Channel configuration	The configuration of imc ARGUSfit-channels can now be copied and pasted from one channel to another one by means of the keyboard combinations CTRL+C/CTRL+V. This matches the method for imc DEVICES.

### Note

### Firmware update - Compatibility

A device belonging to firmware group B with imc DEVICEcore Firmware Version 3.6 R4 (under imc STUDIO 2023 R4) can not be downdated to Firmware Version 3.6 R3 (under imc STUDIO 2023 R3). For imc STUDIO 2023 R3, a patch can be requested from our tech support. Add this number to your query: IT041172.

### 1.4.4 Setup and Device Control



#### Access to the preprocessing also via the simplified view

Preprocessing is now also available in the simplified view "Standard".

By means of the preprocessing, it is possible, among other things, to perform data reduction on imc ARGUSfit channels. For this purpose, various reduction methods are available (Mean Value, Min, Max, ...).

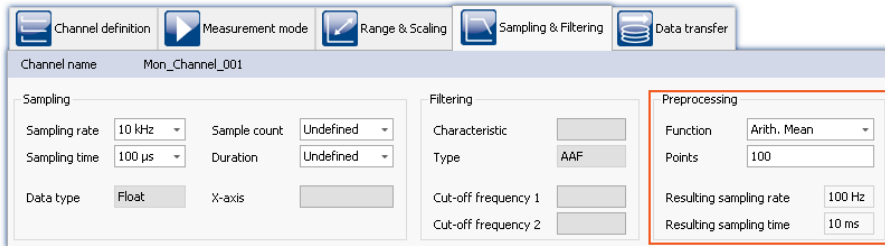

Info on compatibility: existing views will not be modified automatically. To obtain this functionality, the Standard-view must be reset.

#### Stipulated sorting according to devices

Sorting of the triggers according to their names has been deactivated. Internally, the sorting is always performed according to the hidden columns "Device SN" and "Trigger ID". In this way, the positions of the triggers always remain intact.

Triggers

Trigger name	Trigger ID	Device SN	Source
Trigger_01	1	126678	Channel
a_Trigger	2	126678	Channel
Channel_003_Trigger	3	126678	Channel
Trigger_001_T_4160044	1	4160044	Channel
a_Trigger_T_4160044	2	4160044	Channel
Channel_003_Trigger_T_4160044	3	4160044	Channel



### Parameter set export - more precise selection

More precision is available in choosing parameter sets for export of the configuration. By separating the criteria "Channels" from "Parameters", it is now possible to make a more specific selection of desired parameters.

The file thus generated only contains the information required. This means that in many cases any subsequent re-processing and data reduction are no longer necessary.

When export of the parameter set is performed via the menu ribbon item "Setup-Configuration" > "Export configuration", the selection dialog appears as follows:

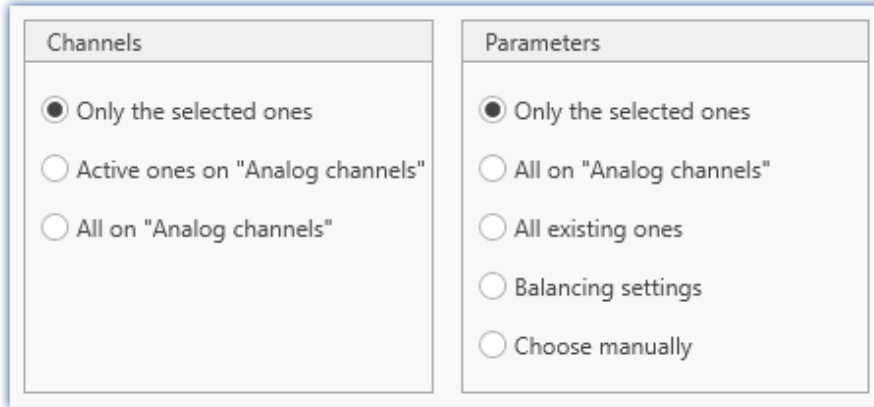

The left column presents the selection of channels whose parameters are to be exported. The choices offered are only the selected channels, or only the channels set to "active", or all channels.

The right column presents the selection of the parameters to be exported for the channels.

Selection	Description
Only the selected ones	All parameters which are selected are exported.
All on "Page name"	All parameters are exported which are visible on the page. These included all columns in the table, but also all parameters in the dialogs and on additional tabs (e.g. the three tabs on the page: "Channel balance")
All existing ones	All parameters defined in the table description are exported. (Including such which are not present in the table.)
Balancing settings	The balance settings are exported, regardless of the Setup page selected.
Choose manually	A dialog for selecting the desired columns appears. In this dialog, select all parameters which you wish to export. All parameters selected are exported.



### Exchanging values between devices

imc ARGUSfit devices can send values to the Display variables of imc devices belonging to firmware group A (e.g. imc CRONOS, imc C-SERIES, ...). However, reception of values from other devices is not possible.

In this way, it is possible to integrate imc ARGUSfit devices into existing measurement setups which require the exchange of Display variables.

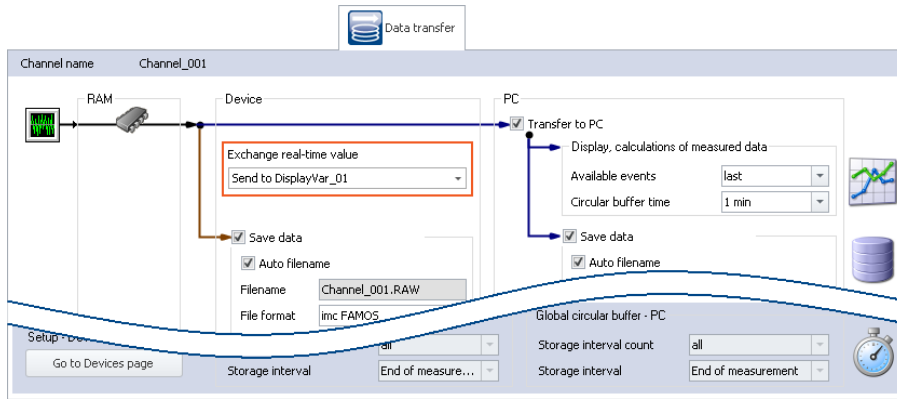

Assigning an imc ARGUSfit channel to a Display variable

### 1.4.5 Metadata



#### Saving metadata with the channel

Metadata can be saved directly in the channel file. No separate file is created. This means the relevant information is saved **in all channels** and thus **in all channel files** on the PC hard drive.

#### Column selection

In the Options "Setup" > "Traceability of data", you have the choice of which groups of parameters to save.

Various groups of Setup-parameters are available for selection, which can also be saved. The tooltip for each of these selections contains an exact list of all parameters. Here is an overview:

Groups	Description
Basic information	Device serial number, channel number, module serial number
Hardware information	Among others connector, channel type, module number, module type, amplifier calibration date
Channel settings	Among others measurement mode, coupling, offset, factor, bridge parameters, inc.-parameters, filter parameters
Metadata	All user-defined metadata columns, which had been created for the channel

#### Reading out metadata

Use the following imc FAMOS-commands in order to read out the metadata saved with the channel: [UserPropText?](#) (for texts) or [UserPropValue?](#) (for numbers).

Access to the metadata via placeholders is not possible at this time. For this reason, simple display on the Panel and as a column in the Data Browser are not yet available.

## 1.4.6 Python

The Python command supplies functions which provide a bridge to the Python programming language. imc STUDIO generates an embedded instance of the Python runtime environment, which provides an interpreter for the Python programming language.

Python is an all-purpose object-oriented programming language which enjoys widespread prevalence especially in education and science/technology due to its accessibility for beginners, its platform independence, expandability and its free availability (Open Source). A large number of libraries are available, e.g. for numerical calculations, visualization of data, image analysis and all the way to machine learning. Familiar expansion libraries for the field of science and technology include NumPy, SciPy and TensorFlow.

For the purpose of analyzing the measured data, a Python code file is selected. The variables to be analyzed with Python can be selected, and the results can be returned in variables.

### Data types

The following variable types can be transferred **to Python**:

- single values (numerical),
- standard channels (uniform, equidistantly sampled channels, not time-stamped)
- individual trigger releases of a standard channel (only as "last event")
- segmented channels (e.g. FFT) and
- vectors

What can not be transferred are such channel properties as the sampling rate, time, unit, ... .

The following data types can not be used:

- text-variables
- time-stamped, non-equidistant channels (TSA, ...)
- multiple trigger releases of a channel (event-based channels)
- similar data types

Various **return value types** are supported, e.g:

- single values (numerical) or
- arrays, interpretable as a normalized channel with a sampling interval of: 1.

Transfer and processing of the variables is performed on the basis of the "*Current Measurement*" and not on the basis of any saved (earlier) measurements.

### System requirements

Support is provided exclusively for the Python reference implementation from the "*Python Software Foundation*" (CPython) in one of the versions listed below; these can be downloaded and installed from <https://www.python.org/>.

- Python 64 bit is installed
- Compatible Python versions: 3.11, 3.10, 3.9 and 3.8 (64 bit)

### 1.4.7 Explorer-Preview



#### Measured data in the Windows-Explorer's Preview window

imc FAMOS files (\*.dat) can be displayed by the Microsoft Windows-Explorer using the Preview-function.

This function is now also available without having to install imc FAMOS. Installation of imc STUDIO also enables this function.

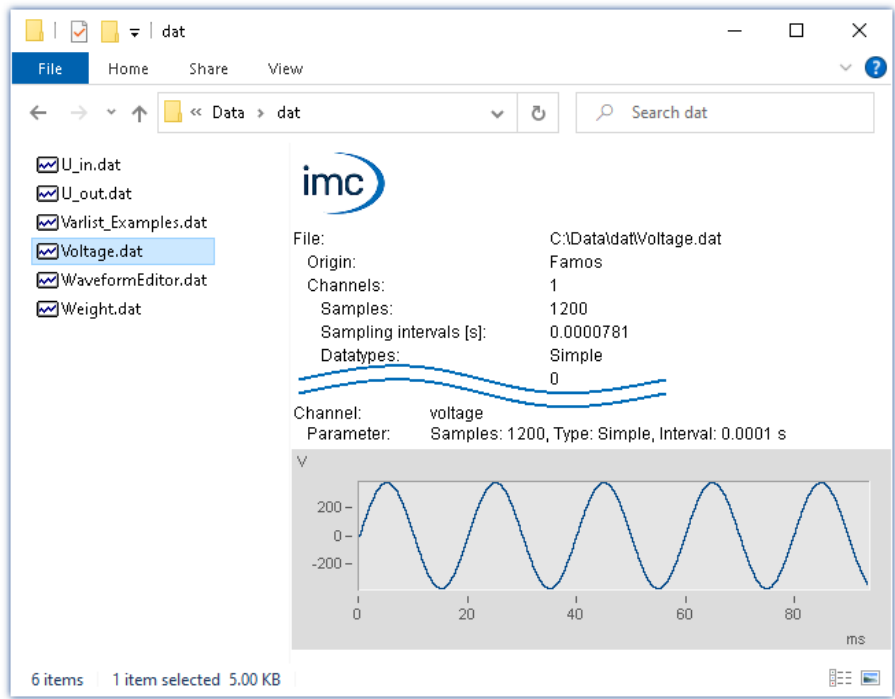

Activation of these functions for \*.raw without imc FAMOS is not possible at this time.

### 1.4.8 Miscellaneous optimization

Alongside minor bug fixes, the following important improvements have also been implemented:

Area	Description
Setup	<p>In some cases, channels' units would not be displayed correctly. For instance, "°C" became "?C" and "µm/m" became "?m/m". This problem was caused by certain mixed language settings for the format in Windows.</p> <p>The problem persists in channels when are created with the imc CANSAS software. Other channels are no longer affected.</p>
Parameter set export	<p>The .data-folder is only created when metadata are also exported and saved there. E.g. PDF-files or images. Previously, the folder was always created whenever a parameter set was exported.</p>
imc Online FAMOS	<ul style="list-style-type: none"> <li>• New menu action "Undo all": Reverses any changes which have been made to the source text since the Editor was called.</li> <li>• In the imc Inline FAMOS Editor's toolbar there is now an "Undo" button. In return, the button "Close dialog" is omitted, since this is usually accomplished using the "X" button.</li> </ul>
Widgets	<p>Table (e.g. Automotive):</p> <p>The texts of the zones were not displayed in the dropdown-list of the cells. Only the values for the zones were displayed.</p>



Area	Description
Curve window	The color map setting for " <i>Interpolation, cubic polynomial</i> " caused a crash when a vector was displayed.
Logbook	<p>Copying entries, including supplemental information</p> <p>The copied text can now optionally be supplemented with the stack-trace. This helps our tech support to analyze errors reported to us. To do this, open an entry's context menu and select "<i>Copy with details</i>". All of the entry's information is then copied to the Clipboard.</p> <p>Additionally, the text resulting from normal copying has been slightly adapted.</p>
User administration	<ul style="list-style-type: none"> <li>• If a user did not have experiment saving privileges, then they could also not load any experiment. Upon loading, the system would check whether any changes would need to be changed, and this prevented loading from proceeding. Now in such cases, any changes are ignored, so that users having this role can also easily load an experiment.</li> <li>• The privilege "<i>Sequencer: Visible event scope</i>" took no effect. Now the respective event ranges are hidden according to the privileges specified.</li> </ul>
Scripting	<ul style="list-style-type: none"> <li>• By means of the new Help-button in the Scripting tool window, it is possible to open the documentation on Scripting directly.</li> <li>• When utilizing a Panel-script, the Run and Stop methods were not called if the Panel was opened on a second monitor.</li> </ul>
API	In the WpfSetParameter-project's ApplicationInterface, the button " <i>Config</i> " is now also operable before any device has been selected. The device list for selecting a device is thus accessible via this button.
GoPro	GoPro HERO8 enables display of the livestream in the widget during running measurement. The other GoPro models still do not offer this ability.
Installation	<p>When a 2023 R3 was installed in parallel with an existing 2022 version, it was no longer possible to open some lists of Setup parameters in the 2022 version. This affected the following areas, among others:</p> <ul style="list-style-type: none"> <li>• Command: Device action</li> <li>• Default values</li> <li>• Table description</li> </ul> <p>Installation of Versions 2022 and 2023 R4 in parallel is now possible. For Version 2022 R3, it is possible to order a patch from our tech support if this error occurs. When making this request, provide this number: IT041164.</p>
Translation	Numerous texts have been translated into Japanese.

## 1.5 imc STUDIO 2023 R3

### 1.5.1 General Changes in imc STUDIO



#### Panel - Demo-pages

There are a variety of Demo-pages which provide a quick overview of how a Panel page can look and of which functions are available. These are found in the "Page repository".

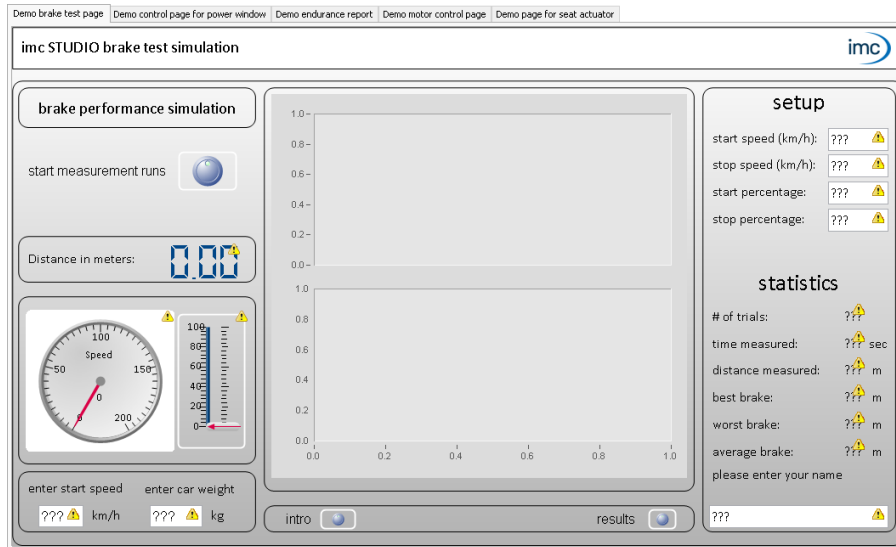

#### Opening an experiment for a different device

In the "Open Experiment"-dialog, the selected can now not only be opened but also transferred to a different device.

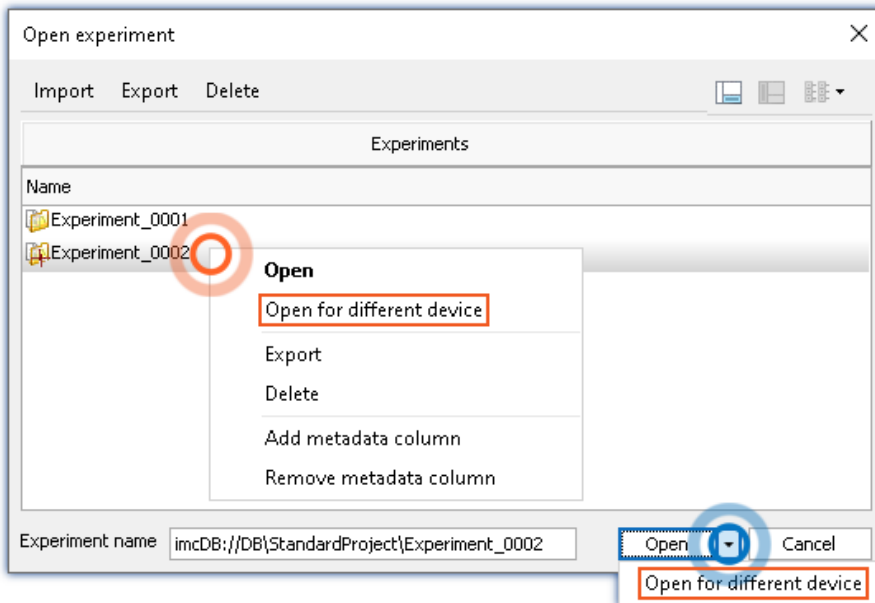

This is possible by using the experiment's context menu or by means of the "Open"-button's drop-down-list.



Additionally, some improvements have been made to the dialog user guidance.

## 1.5.2 Firmware and new hardware

This imc STUDIO version has been released along with the following firmware and devices driver packages:

- [Firmware imc DEVICES 2.16 R3](#) 
- [Firmware imc DEVICEcore 3.6 R3](#) 

### 1.5.2.1 Firmware imc DEVICES 2.16 R3

Alongside minor bug fixes, the following important improvements have also been implemented:

Area	Function
CAN assistant	When an A2L-file was imported whose name plus the pathname contained more than 122 characters, import failed.
CAN-Interface	In the Prepare stage, the device would restart when other channels besides an ECU configuration were created in the CAN-configuration.
XCP on CAN	<ul style="list-style-type: none"><li>• For the XCP-protocol, it is now possible to extract the ECU reception channels from the log channel. Sending channels are not supported. The ECU-channels can be decoded from the log channel either after measurement with imc FAMOS or during measurement with Bus Decoder.</li><li>• When decoding digital channels, the original names from the A2L-file are now used.</li></ul>
imc BUSDAQflex with CANFD	The device restarted in response to high data volume on multiple CANFD-nodes.
imc BUSDAQflex	A watchdog now monitors the WLAN connection. This ensures that the WLAN connection is re-established even if no DHCP server is available at the time of waking up (even with WakeOnCAN). The watchdog checks at regular intervals whether the DHCP server is available again and requests an address.

## 1.5.2.2 Firmware imc DEVICeCore 3.6 R3

### Hardware

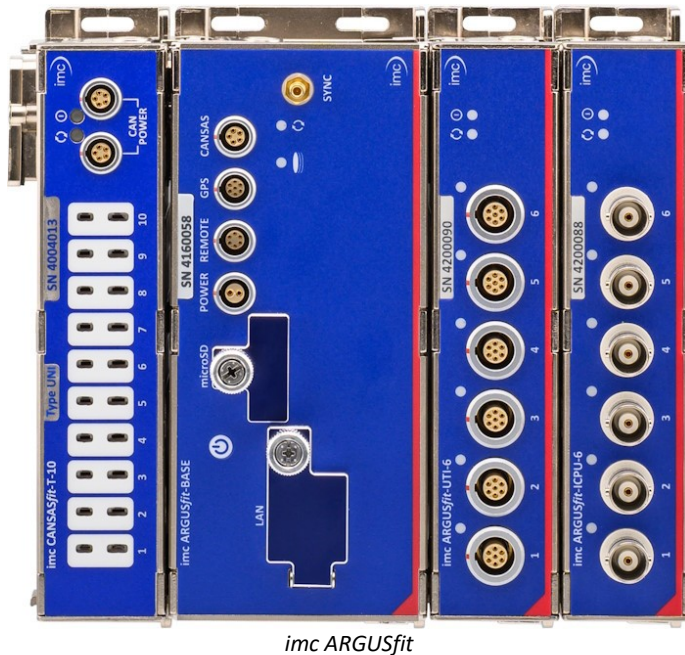

#### imc ARGUSfit - At a glance

- Very compact, high-performance data acquisition system
- Particularly flexible: modular system without mainframe
- Click mechanism: connects modules electrically and mechanically
- Decentralized installation via fiber optic cables
- Up to 5 MSample/s aggregate system sampling rate
- High channel data rates (and bandwidths), up to 500 kSample/s at 24-bit resolution, depending on the module type
- Multiple individual channel sampling rates
- Integrated real-time analysis through built-in imc Online FAMOS
- Full integration of imc CANSASfit
- Combination with all imc system families and synchronous acquisition of thousands of channels

### imc ARGUSfit – fast, compact and modular measurement systems

imc ARGUSfit is a compact modular system that allows the user to flexibly assemble fast data acquisition systems (DAQ). Both the base unit and the flexibly combinable measuring modules have independent housings which are connected by a "click" mechanism (no tools required) to form a DAQ system.

imc ARGUSfit covers the entire frequency range of physical measurement applications with a aggregate sampling rate of up to 5 MS/s and channel rates of up to 500 kSample/s, depending on the module type. Various such measurement modules for common signals and sensors are available and more will be released in the future.

The system achieves particular flexibility by extending modularity even to decentralized topologies. The internal system bus can be converted to fiber optic cables by means of a media converter extension module in order to integrate spatially distributed module blocks.



imc ARGUSfit also provides complete integration of the imc CANSASfit module series for slower channels, e.g. for temperature measurement. Such imc CANSASfit modules (CANFT) are likewise internally connected with power and CAN bus and are fully supported and integrated by the software as a uniform system. Finally, imc CANSASfit modules can even be installed in distributed topologies and connected via CAN-cable to the imc CANSAS-Interface of the base unit.

Multiple DAQ systems of the imc ARGUSfit series as well as other imc data logger and measurement systems can be interconnected via Ethernet. This provides the ability to operate very large and multi-channel setups in which different imc device series work together seamlessly and in complete synchronization.

## imc Online FAMOS



### Data analysis in the measurement device: Results in real time

imc Online FAMOS is a powerful extension included in every imc ARGUS*fit* DAQ system as a standard without any additional license required. It offers a variety of real-time functions for pre-processing and signal analysis. The mathematical analysis functions are executed on the signal analysis platform integrated in the measurement device. This means that analysis results are available immediately and also independently of the PC. Such pre-processing can also yield significant data reduction and thus reduce the amount of data to be exchanged between the DAQ system and the PC. The results are available in imc STUDIO as virtual channels.

imc Online FAMOS is now available in a limited version for imc ARGUS*fit* devices.

### Supported functionalities

Currently, the functionality of imc Online FAMOS for imc ARGUS*fit* comprises all major math and standard analysis functions. The following special functionalities are not supported yet:

- imc ARGUS*fit* does not provide any virtual bits and display variables or comparable system variables.
- pv-variables cannot be created.
- imc Online FAMOS Professional with synchronous tasks is not available and thus imc STUDIO Automation for real-time test automation is not supported.

Note: Supplemental files are imported via the imc Online FAMOS dialog and not via the Setup menu ribbon.

## Miscellaneous optimization

Alongside minor bug fixes, the following important improvements have also been implemented:

Area	Function
Device time	The device time is reset along with resetting of the PC-time upon preparing the device.
Devices list	It was not possible to remove the device from the Devices list (details: set as unknown) if the device was set with an unreachable IP.

### 1.5.3 imc SIMPLEX



imc SIMPLEX enables extremely fast configuration of imc ARGUSfit-channels by means of validated sensor settings prepared in a cloud. This massively reduces the risk of errors in configuring a measurement system.

S		i		M		P	
Sensor Serial No	0815-0123-9876						
Type of Measurement	Acceleration						
Signal Name	AccelerationSignal01						
Measurement							
Type of Measurement	Acceleration						
Signal Unit	m/s <sup>2</sup>						
Secondary Unit	V						
Parameters							
Sensor Sensitivity	0.66667 V/m/s <sup>2</sup>						
Measuring range	3.75 m/s <sup>2</sup>						

#### Simple:

- When you scan a sensor with your cell phone, the sensor is displayed in imc STUDIO. By means of Drag&Drop it can be dragged to the target channel. The channel adopts all of the sensor's information and is ready for measurement.
- When you have a pile of cable terminals in front of you, how do you know which one is the right one? Simple: all cable terminals are equipped with RFID. The app lets you scan the cable terminals and obtain the info indicating what terminal you are holding in your hand.
- You have a cabinet full of sensors in their packaging. The packaging is equipped with RFIDs. Using the app, you can scan a package to find out what sensor it contains and whether it is right for your measurement, and even whether it is already appropriately calibrated.

All this is possible thanks to imc SIMPLEX.

#### Product overview

imc SIMPLEX consists of three components: the imc STUDIO plug-in, the mobile app and the website.

Using the website interface and the mobile app it is possible to set up and configure sensors. This determines which imc measurement modules can measure with the sensors. The finished sensor configuration is made available in a database. If the sensor is equipped with RFID, a barcode or QR-code, it can be scanned with a cell phone. imc STUDIO then provides the appropriate sensor configuration to apply to the channel. It is also possible to enter specific measuring point definitions including harmonized signal names, or generic sensor types.

#### Functions

- Access to imc SIMPLEX sensor database via the Internet. The sensor database is supplied by imc.
- Sensor configurations are saved in the database. There is no limit on the sensor count.
- The sensors are either set up/edited via the website, or with certain limitations via the mobile app.
- The sensor configuration comprises everything from the measurement type (temperature, pressure, ...), to calibration (offset, sensitivity), all the way to the sampling rate.
- imc SIMPLEX provides an indication of which modules the sensor is suitable for.
- The sensors are made available in imc STUDIO and can be dragged to the desired module channels, which then apply the entire configuration.
- It is possible to assign RFID-tags to the sensors. The RFID can be applicable either to individual sensors or to a whole sensor type. Example: the RFID is attached to a sensor or a cable, or it is attached to a box and pertains to all of the sensors in that box.

- A cell phone can scan the RFID, and the app then automatically displays all of the sensor's information. The Sensors list in imc STUDIO displays the corresponding sensor so that its entry can easily be dragged to the desired channel. This is possible whenever the same imc SIMPLEX user is logged in to both the PC and the app.
- In order to use imc SIMPLEX, each user needs a user account. These user accounts can be set up by the database's designated administrator. For this purpose, a variety of user roles having associated privileges are available:

Function	Reader	Editor	Admin
Sensor reading	•	•	•
Sensor assignment to channel	•	•	•
RFID scanning	•	•	•
Sensor setup		•	•
Sensor editing		•	•
Sensor deletion		•	•
User setup			•
User role editing			•

### Supported imc measurement device groups

A device belonging to the firmware group B - e.g. imc ARGUS*fit*, imc EOS.

### System requirements

- Browser: an up-to-date browser
- Cell phone operating system: Android 5 or higher, or IOS 10.3 or higher (find details in your respective app store)
- Cell phone: NFC-enabled or barcode/QR code enabled, depending on application
- imc STUDIO 2023 R3 or higher
- Connection to the internet with access to the imc SIMPLEX server

### Licensing

Licensing is independent of imc STUDIO and the imc LICENSE Manager.

- **Separate licenses** are required for imc SIMPLEX, which cover the **use of the cloud services** and the imc SIMPLEX Assistant.
- The license model is a **subscription** that is activated or renewed by **paying an annual fee**.
- Licensing involves creating user accounts on the imc SIMPLEX server. Upon order, the number of allowable user accounts is specified. Later extensions are supported.
- A user account includes the authorization to log in to the imc SIMPLEX server via the mobile app, the website and via imc STUDIO. In addition, depending on the configured user role, it allows the configuration and/or readout of sensor information. A user account is not bound to specific devices.
- The installation of the mobile app and the imc STUDIO plug-in are license-free. However, their meaningful use requires log-in with a licensed user account.

## 1.5.4 Miscellaneous optimization

Alongside minor bug fixes, the following important improvements have also been implemented:

Area	Description
Setup - Default values	It had not been not possible to set the parameter for a default value. Instead, an error was reported.
fos4X	Measured data from 3rd-party fos4X-devices had previously not been saved in intervals. Now it is also possible to activate interval data saving for these devices.
Sequencer	Discontinued: Sequencer command " <i>Transfer device settings</i> " The command " <i>Transfer device settings</i> " is no longer supported. Notes on compatibility: Load an experiment belonging to the predecessor version which contains this command: In the sequence in which you use this command, an "empty" command is inserted as a placeholder to mark the location.
Sequencer	The context menu in the Sequencer's Events area could not be opened if the user role had previously been changed, if the project had previously been switched, or if an experiment was transferred to a different device.
User-defined events	The user-defined events " <i>Trigger Start</i> " and " <i>Trigger Stop</i> " for a trigger having a defined source would fire if the BaseTrigger fired. Now the BaseTrigger does not release the user-defined trigger events of other device triggers.
Automation	When imc CANSAS was opened, an existing Automation configuration was lost.
Inline Analysis	<ul style="list-style-type: none"> <li>Monitor channels can now be used as the input channels of calculations.</li> <li>When the IEPE calibration window was called twice in succession, imc STUDIO no longer reacted.</li> </ul>
imc Inline FAMOS	<ul style="list-style-type: none"> <li>When a saved experiment contained source text for imc Inline FAMOS, no message was posted if the component imc Inline FAMOS was not activated. Now, an error message is posted upon loading the experiment to indicate that the component must be activated in the "<i>Product configurator</i>".</li> <li>When an imc FAMOS analysis was performed only with 3rd-party devices, upon starting the measurement, the message "<i>BaseTrigger: Channel name empty</i>" was always shown.</li> </ul>
Powertrain Monitoring	It had not been possible to successfully check the configuration in the view " <i>Show configurations</i> " if a dropdown-box for the drive elements was previously filled in.
Scripting	In the Scripting, for imc Inline FAMOS functions, the return variable type " <i>Result</i> " has been changed to " <i>IssueResult</i> " in order to avoid collisions with the variables-functions.
imc STUDIO API	With API, the Channels list in the WinForms example now is sorted alphabetically.
Product configuration	In the " <i>imc STUDIO Standard</i> " edition, Data Processing is now activated by default. Previously, there had been a problem in which a Data Processing-component such as Bus Decoder or imc Inline FAMOS would fail to be displayed upon being activated, because Data Processing additionally needed to be activated.  Still applicable: If Data Processing is deactivated manually, it will not activate automatically when another Data Processing component is activated.
User administration	The menu action " <i>Save experiment</i> " did not update the state when the user was changed. Therefore, it was not possible to save an experiment if the previously logged in user did not have the right to save. Now the state of the menu action is updated when the user is changed.
Options	When the dialog for calling the database path is called, the system now highlights the currently selected folder as the default choice.



---

Area	Description
Installation	When installing imc DEVICES by means of the imc STUDIO-Installer, the J1587-packet is no longer included in the installation.
Deinstallation	Deinstallation failed to remove the entry " <i>imc STUDIO Logbook</i> " from the Start menu.

---

## 1.6 imc STUDIO 2023

### 1.6.1 General changes in imc STUDIO

#### Setting the expected signal value range in addition to the measurement range

For some sensors, it is sometimes desirable not only to define the measurement range, for example  $\pm 10$  kN or  $-270..500$  °C, but also an expected value range, e.g.  $0..9$  kN or  $20..80$  °C. The expected value range is usually only a subset of the measurement range. The intention would be to display only values within that range in order to be able to directly concentrate attention on the relevant portion.

Whenever values outside of this range are measured, they are to be considered overmodulation. This provides a quick indication that something is not right at the moment, even if there is no actual overmodulation from an electrical standpoint.

When such a display range is specified, the measurement range is initially used as the display range for the Widgets. Instead of assuming the fixed values  $0..10$  as previously, the system now uses the channel's display range directly. Thus, it is not necessary to adjust the range for every Widget.

With all Widgets, it is still possible to set a different range, so that it is possible to display a variety of ranges.

## Details on changes implemented

### Renaming of Setup-parameters

Setup page: "Analog/Digital channels" - Dialog "Curve properties"

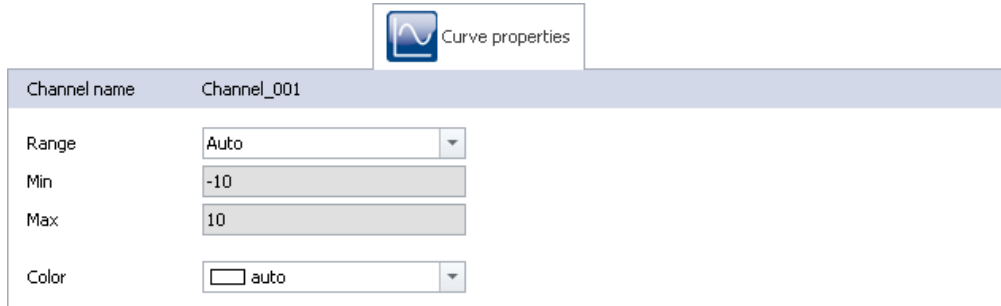

Old name	New name		
	<i>long name</i>	<i>short name</i>	<i>column ID</i>
Y-axis option	<i>y-axis range</i>	<i>Range</i>	<i>eCurveYAxisOption</i>
Y-axis min	<i>y-axis min</i>	<i>Min</i>	<i>eCurveYAxisMin</i>
Y-axis max	<i>y-axis max</i>	<i>Max</i>	<i>eCurveYAxisMax</i>

#### Notes on compatibility:

When designations of parameters are changed, modifications are necessary if these parameters are used in a "Parameter set file". If you import existing parameter set files containing these parameters, please revise these files, replacing all instances of them using a text editor.

### Level indicators

#### "Current value"-column in the Setup, as well as the Widget "Level indicator"

The level indicators previously used the measurement range for the upper and lower boundaries. If the parameter "y-axis range" is set to "User-defined", you can define an expected value range for the sensor by means of the parameters "Y-axis min" and "Y-axis max".

When values outside of this range are measured, the level indicators indicate overmodulation even when there is none from an electrical standpoint.

#### A range is always provided

The channel now always provides the Widgets with a display range. The Widget uses this range by default, but can also use a custom range. By means of the property "y-axis range" you define how the Widget is supposed to respond.

Choice	Previous function	New function	Affects the Widgets
Auto	No transmission of range information	<b>Max- and Min-values match the measurement range set for the channel</b>	<ul style="list-style-type: none"> <li>• scale-Widgets</li> </ul>
Input range	Max- and Min-values match the measurement range set for the channel	<i>no change</i>	<ul style="list-style-type: none"> <li>• scale-Widgets</li> <li>• curve window (rezoom)</li> </ul>

Choice	Previous function	New function	Affects the Widgets
User-defined (min, max)	Max- and Min-values can be set in the parameters further below	<i>no change</i>	<ul style="list-style-type: none"> <li>• scale-Widgets</li> <li>• curve window (rezoom)</li> </ul>

By default, Widgets such as the pointer instrument or the bar chart, now use the specified measurement range or the fixed specified display range of the channel. In many cases, no modification is necessary any longer, or the range can be governed by means of the parameters for all Widgets which display the channel.

**Notes on compatibility:**

When loading existing experiments, observe the following: Upon conversion, all existing Widgets are set so that they do not use the channel's specified range. Background: By default, the Widgets are set to adopt the range. However, no range had previously been transferred when the channel setting for "y-axis range" was set to "Auto". Since a range is now always transferred, not all Widgets would display the previously set range. In case you have already used this function anyway, please modify this property's value. Open the Widget's Properties and change the setting "Range" to "From Variable".

**1.6.2 Introduction and operation aids**



**What steps are needed for obtaining measured data?**

An Assistant is provided to help you become familiar with the system. The first steps – selection of the device, channel configuration and display of the measured data – are usually identical.

Start the Assistant from the homepage directly after starting imc STUDIO. Click on "Let's go" ①. You are able to start and repeat the Assistant again at any time.

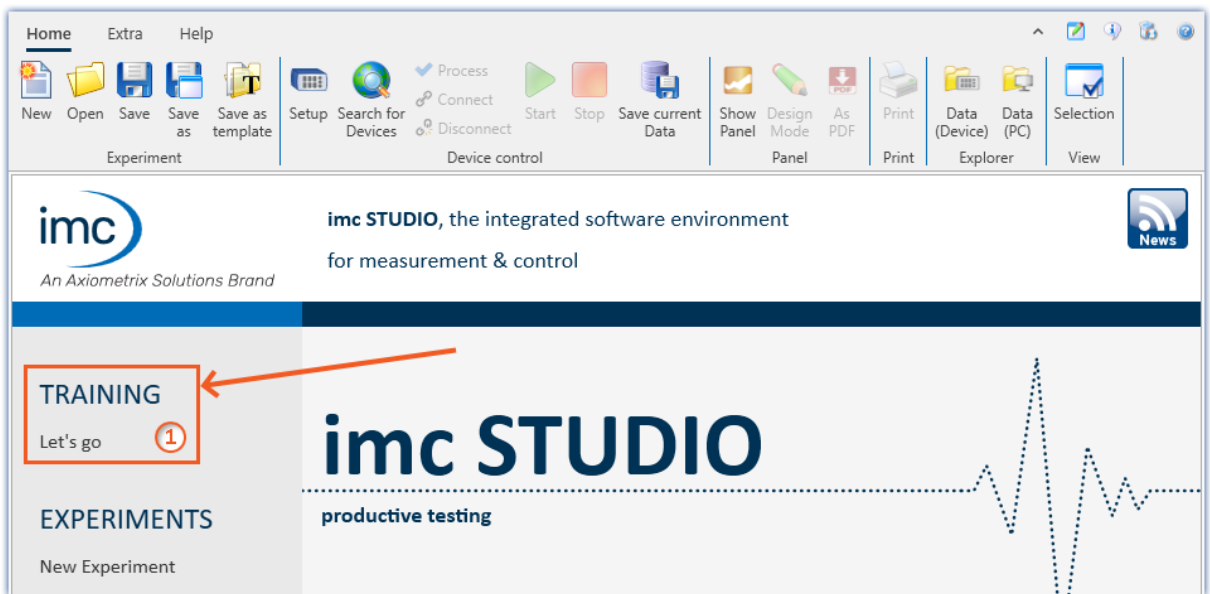

Starting the Assistant

A dialog appears, in which the next steps are explained to you. As an aid in orientation, a pulsating circle ② appears in the imc STUDIO user interface in order to highlight the interface element with is the topic of the descriptive text.

As shown in the example below, the next step is to open the Devices list. To do this, it is enough to click on the button "Setup" in the menu ribbon. The Assistant recognizes when the assignment has been completed, and only then enables the "Next"-button ③.

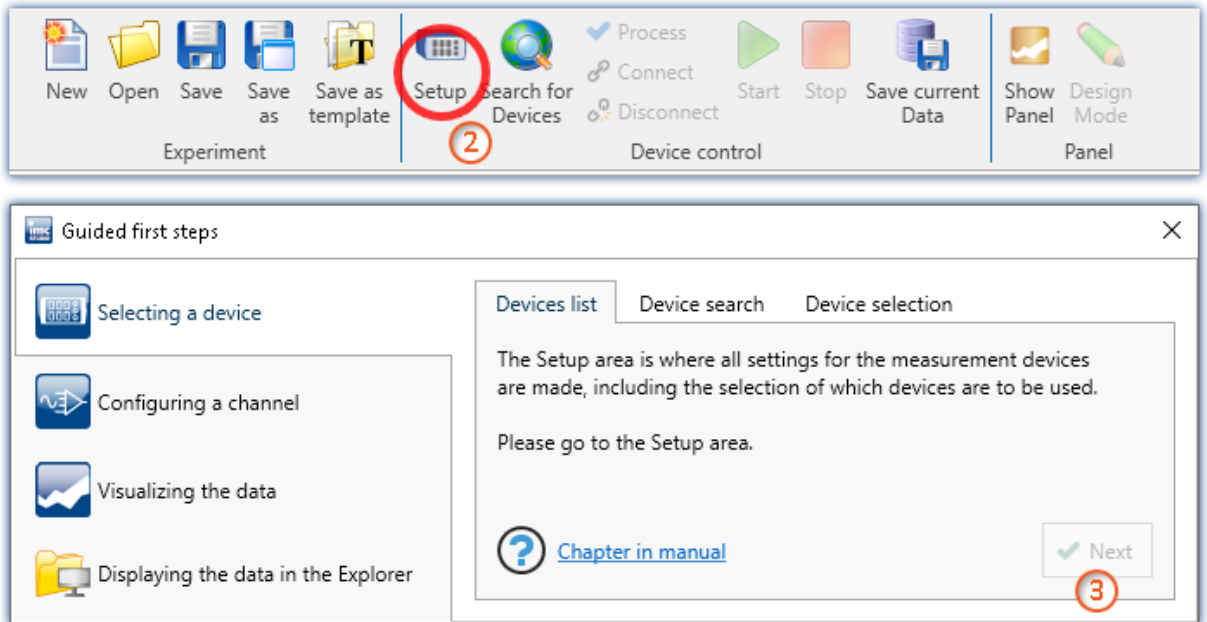

*Der Assistent gibt Hilfestellung durch grafische Hervorhebungen und informierende Texte*

By means of the tabs, you can repeat or skip steps.

Each page contains a link to the pertinent section in the user's manual, where you can find advanced descriptions of the respective pages and steps.



## Help with the device's network configuration

By means of the device interface's configurations dialog, you can directly open the PC's adapter settings **①**. Additionally, there is a direct link at the bottom to the section of the documentation which deals with interface configuration **②**.

Device interface configuration ✕

<div style="font-size: x-small; font-weight: bold;">Devices found (serial number)</div> <ul style="list-style-type: none"> <li>Currently not reachable</li> <li>Recently edited</li> <li>Ready for measurement                             <ul style="list-style-type: none"> <li>T_122339_CS7008 (122339)</li> <li>T_123020_CRPL_2_DIO (123020)</li> <li>T_123310_CS1208 (123310)</li> <li style="background-color: #e0e0e0;">T_126678_CS_7008_1 (126678)</li> <li>T_126679_CS_7008_1 (126679)</li> <li>T_126680_CS_7008_1 (126680)</li> <li>T_130098_busDAQ_X (130098)</li> <li>T_130820_busDAQ_X (130820)</li> <li>T_132704_BUSFX_2_S (132704)</li> <li>T_140165_CRC_400 (140165)</li> <li>T_140562_CRC_400 (140562)</li> <li>T_141127_CRFX_400 (141127)</li> <li>T_142115_CS_7008_N (142115)</li> <li>T_142203_CS_7008_N_1 (142203)</li> <li>T_142996_CRFX_400 (142996)</li> <li>T_144431_CS_7008_FD (144431)</li> <li>T_144432_CS_4108_FD (144432)</li> </ul> </li> </ul>	<div style="font-size: x-small; font-weight: bold;">Device information</div> <p style="font-size: x-small;">Device name: T126678_CS_7008_1 SN: 126678 Device identifier: imcDev_12126678</p> <table border="1" style="width: 100%; border-collapse: collapse; font-size: x-small;"> <tr> <td style="width: 50%; font-weight: bold;">Current PC configuration</td> <td style="width: 50%; font-weight: bold;">Current device configuration</td> </tr> <tr> <td>Configuration type: Manually configured <span style="border: 1px solid red; border-radius: 50%; padding: 2px;">⚙️ ①</span></td> <td>Configuration type: Manually configured IP a...</td> </tr> <tr> <td>IP address: 10.0.11.75</td> <td>IP address: 10.0.11.86</td> </tr> <tr> <td>Subnet mask: 255.255.255.0</td> <td>Subnet mask: 255.255.255.0</td> </tr> <tr> <td>Gateway: 10.0.0.1</td> <td>Gateway: 10.0.0.1</td> </tr> <tr> <td>DNS server(s): 10.0.0.10</td> <td>DNS server: 10.0.0.10</td> </tr> </table> <div style="font-size: x-small; font-weight: bold;">New device configuration</div> <p style="font-size: x-small;">Interface: <span style="border: 1px solid gray; padding: 2px;">LAN</span></p> <p style="font-size: x-small;">Configuration type: <span style="border: 1px solid gray; padding: 2px;">Manually configured IP address</span></p> <p style="font-size: x-small;">IP address: <span style="border: 1px solid gray; padding: 2px;">10.0.11.86</span> <span style="font-size: x-small; font-weight: normal;">e.g. 192.168.0.2</span></p> <p style="font-size: x-small;">Subnet mask: <span style="border: 1px solid gray; padding: 2px;">255.255.255.0</span> <span style="font-size: x-small; font-weight: normal;">e.g. 255.255.255.0</span></p> <p style="font-size: x-small;">Gateway: <span style="border: 1px solid gray; padding: 2px;">10.0.0.1</span> <span style="font-size: x-small; font-weight: normal;">e.g. 192.168.0.1</span></p> <p style="font-size: x-small;">DNS server: <span style="border: 1px solid gray; padding: 2px;">10.0.0.10</span> <span style="font-size: x-small; font-weight: normal;">e.g. 192.168.0.1</span></p> <p style="font-size: x-small;">Domain: <span style="border: 1px solid gray; padding: 2px;"> </span></p>	Current PC configuration	Current device configuration	Configuration type: Manually configured <span style="border: 1px solid red; border-radius: 50%; padding: 2px;">⚙️ ①</span>	Configuration type: Manually configured IP a...	IP address: 10.0.11.75	IP address: 10.0.11.86	Subnet mask: 255.255.255.0	Subnet mask: 255.255.255.0	Gateway: 10.0.0.1	Gateway: 10.0.0.1	DNS server(s): 10.0.0.10	DNS server: 10.0.0.10
Current PC configuration	Current device configuration												
Configuration type: Manually configured <span style="border: 1px solid red; border-radius: 50%; padding: 2px;">⚙️ ①</span>	Configuration type: Manually configured IP a...												
IP address: 10.0.11.75	IP address: 10.0.11.86												
Subnet mask: 255.255.255.0	Subnet mask: 255.255.255.0												
Gateway: 10.0.0.1	Gateway: 10.0.0.1												
DNS server(s): 10.0.0.10	DNS server: 10.0.0.10												

Apply
Reset

Help ②
Advanced Configuration
Close



## Various other aids in introduction and operation

- Sample-Widgets for starting/stopping measurement are provided in the "*Repository*".
- Hot Tracking: Supposing you wish the Setup-tables to show which parameters belong to the same channel. A channel's name appears at the left, and at the right, the respective channel's sampling rate is stated. To make this easier to recognize, the entire row is now highlighted whenever the mouse cursor moves over it.
- The homepage has been revised and de-cluttered so that certain functions can be more easily and quickly found.
- Import of experiments has been simplified:
  - If the export file doesn't contain any measured data, the system does not ask whether measured data are to be imported.
  - If the export file contains only one experiment, the selection of experiments to import is skipped.
  - If an experiment of the same name already exists, the system asks whether to overwrite or rename it.

## Quick access toolbar

The Quick Access Toolbar has been reduced down to only relevant actions.

This toolbar always provides rapid access to the important actions. There should not be too many of these, in order to avoid losing a good overview. The toolbar has thus been limited to the following actions: "*Open experiment*", "*Save experiment*", "*Start measurement*" and "*Stop measurement*".

It remains possible for the user to customize the quick access toolbar.

### Notes on compatibility:

Existing views are not automatically modified and remain unchanged.

## 1.6.3 Firmware and new hardware

This imc STUDIO version has been released along with the following firmware and devices driver packages:

- [Firmware imc DEVICES 2.16 \(R2\)](#)  47
- [Firmware imc DEVICEcore 3.6 \(R2\)](#)  49

### 1.6.3.1 Firmware imc DEVICES 2.16 (R2)

## Seamless Integration of 3rd Party Devices, Sensors, and Equipment

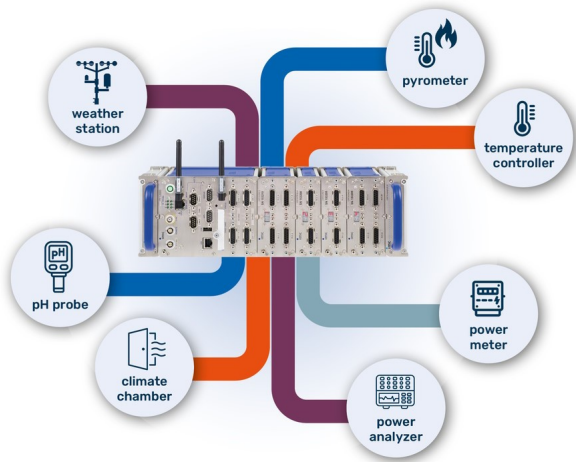

### New Modbus Fieldbus Interface

The imc Modbus interface is a fieldbus module that can be used to equip imc measurement devices such as imc CRONOS*compact*, CRONOS*flex*, SPARTAN and BUSDAQ. Modbus<sup>1</sup> is a communication protocol widely used in industrial automation devices.

The interface acts as Modbus client and can address and receive data from several Modbus server devices. It is used to integrate 3<sup>rd</sup> party devices equipped with Modbus as additional measurement data sources into imc measurement systems and data loggers.

1: Modbus® is a registered Trademark of Schneider Automation, Inc.

### Typical applications:

- Integration of external devices and sensors with Modbus interface into an imc data acquisition system.
- Extension of the capabilities of an imc system to include specific special functions or sensors that can only be covered by 3<sup>rd</sup> party devices.
- Use of special instruments (e.g. power meters, power analyzers, laboratory instruments), sensors (e.g. humidity or ph sensors, pyrometers), sensor systems (e.g. weather station) or test infrastructure (measurement of current temperature of climatic chambers)
- Low-speed monitoring of environmental parameters and electrical power
- Use of standard equipment from the field of industrial test automation
- Using an imc system as a central platform and gateway, with recording, processing of data from a wide variety of sources (imc system, analog, Modbus, field buses) and exchange and networking with higher-level systems via CAN bus, EtherCAT or XCPoE.

### Features:

- Dedicated processor avoids use of resources of the main processor on the imc system and ensures performance and scalability
- Both protocols and interfaces (physical layer) that are standardized for Modbus are supported: "*Modbus TCP*" (100 Mbit ethernet) and "*Modbus RTU*" (Serial interface - RS232, RS485 half duplex and full duplex)
- Both hardware interfaces are provided on the module (RJ45 and DSUB-9) and can also be operated together, in parallel
- Device-based integration into the measurement system allows the use of all advanced capabilities and functionalities such as live data analysis with imc Online FAMOS, integration into real-time test automation (imc STUDIO Automation) etc.
- Acquisition of input data (measurement data) from Modbus devices, no output via Modbus (no control of e.g. actuators, controllers, etc.)



Reference

See also

Further information can be found in the technical data sheet of the imc Modbus interface.

## Miscellaneous optimization

Alongside minor bug fixes, the following important improvements have also been implemented:

Area	Function
Hardware: Module: LVDT16	No measurement ranges were offered for selection.
Hardware: imc CRONOSflex	An internal error (9934) was corrected, which occurred in very rare cases in consequence of repeated triggering.
CAN-Interface	<ul style="list-style-type: none"> <li>• In spite of only moderate demands on the CAN-node, the error 5101 (aggregate sampling frequency of CAN-channels too high) occurred.</li> <li>• CAN-Assistant For signals in the format "<i>real number</i>", it is now possible to specify a scaling-factor and scaling-offset. If they exist, the factor and offset are also included when importing DBC-files.</li> <li>• CAN-Assistant In a certain case, import of a DBC-file returned the error: "<i>Invalid file format</i>"; error number: 21095. The DBC-file was correct, however one parameter's expected values were not complete and needed to be corrected.</li> <li>• XCP on CAN In certain cases, sending via XCP on CAN caused the CAN-Interface to crash.</li> <li>• XCP on CAN When both nodes of an interface were used for XCP, then on the second node, not all necessary messages were send.</li> </ul>
CAN-FD	<p>When a CAN-FD interface is operated in CAN-Classic-mode, certain very low Baud rates can not be used. For this reason, the following Baud rates are no longer available for selection: All Baud rates below 13333.33 bits/s. The following are also not available:</p> <p>13377.93, 13445.38, 13468.01, 13513.51, 13559.32, 13582.34, 13605.44, 13675.21, 13722.13, 13793.10, 13840.83, 13937.28, 13986.01, 14035.09, 14109.35, 14184.40, 14260.25, 14285.71, 14311.27, 14336.92, 14414.41, 14519.06, 14571.95, 14652.01, 14705.88, 14814.81, 14842.30, 15009.38, 15037.59, 15065.91, 15094.34, 15180.27, 15325.67, 15384.62, 15444.02, 15473.89, 15503.88, 15594.54, 15625.00, 15686.27, 15779.09, 16129.03, 16161.62, 16194.33, 16227.18, 16260.16, 16326.53, 16393.44, 16460.91, 16632.02, 16771.49, 16806.72, 16913.32, 16949.15, 17021.28, 17094.02, 17204.30, 17241.38, 17429.19, 17582.42, 17738.36, 17857.14, 18018.02, 18099.55, 18390.80, 18433.18, 18604.65, 18648.02, 18735.36, 18867.92, 19230.77, 19370.46, 19512.20, 19656.02, 19704.43, 19753.09, 19851.12, 20408.16, 20512.82, 20671.83, 20779.22, 21220.16, 21276.60, 21505.38, 21563.34, 21621.62, 21680.22, 21857.92, 21978.02, 22038.57, 22598.87, 22792.02, 22988.51, 23323.62, 23460.41, 23668.64, 24024.02, 24316.11, 24390.24, 25078.37, 25157.23, 25806.45, 26229.51, 26578.07, 26936.03, 27027.03, 27118.64, 27586.21, 27874.56, 28368.79, 28673.84, 30188.68, 30651.34, 30888.03, 31007.75, 32258.06, 32520.33, 32653.06, 32786.89, 32921.81, 33898.31, 34042.55, 34482.76, 35555.56, 36036.04, 36866.36, 37209.30, 37735.85, 39024.39, 39408.87, 42553.19, 43010.75, 43243.24, 43715.85, 45197.74, 45977.01, 46511.63, 48780.49, 50314.47, 51612.90, 54054.05, 55172.41, 56737.59, 62015.50, 64516.13, 65040.65, 65573.77, 67796.61, 68965.52, 75471.70, 85106.38, 86021.51, 91954.02, 93023.26, 97560.98, 108108.11, 129032.26, 131147.54, 135593.22, 137931.03, 150943.40, 170212.77, 186046.51, 195121.95, 216216.22, 258064.52, 275862.07</p> <p><b>Notes on compatibility:</b></p> <p>When loading any experiment for which one of the rates mentioned is entered, please make a different selection from among the correct rates.</p>



Area	Function
XCPoE-Interface	When the frequency of transmitted XCPoE packets was high, packets could go missing due to an overload of the XCPoE interface. The interface's performance has been optimized so that now up to 10k packets/second can be processed.
imc CANSAS modules	Under some circumstances, adjustment of the Baud rate of multiple imc CANSAS modules no longer worked: upon configuring, a warning immediately appeared, indicating that a module was no longer found.
imc Online FAMOS	The sampling interval of a imc Online FAMOS channel was not modified when the sampling rate was changed in the imc CANSAS-dialog.

### 1.6.3.2 Firmware imc DEVICeCore 3.6 (R2)

Alongside minor bug fixes, the following important improvements have also been implemented:

Area	Function
imc EOS	<ul style="list-style-type: none"> <li>If there was an outage of the power supply to an imc EOS device while it was running, the LED shined red continuously. Now it flashes again, which is the correct behavior.</li> <li>The pre-defined curve window color (channel configuration) was not applied correctly in the curve window.</li> </ul>

### 1.6.4 Setup and Device Control



#### Balancing of all active channels

A new menu item is available, by means of which you are able to balance all active channels. This applies any settings which have been set on the Setup page "Channel balance".

Ribbon	View
Home > Balance	all
Setup-Control > Balance	Complete
Panel-Control > Balance	Complete

#### Notes on compatibility:

This menu action is not automatically contained in existing views. If you wish to continue using your revised views, you can incorporate this menu item by means of the menu ribbon customization.



## New measured values also on other pages by means of the Current value column

The column of Current values now offers an overview of fresh measured data also on the Setup pages "Variables" and "GPS".

### Notes on compatibility:

This column is not automatically included in existing views. If you wish to continue using your revised views, you can incorporate this menu item by means of the column arrangement.

## Optimization of the instantaneous value display

Display of instantaneous values has been optimized to prevent constant flickering of the value display.

The following behavior has been implemented:

- The display of the value depends on the measurement range (or display range). If the measurement range is large, only a few decimal places are displayed. For example, if 50 V is the setting, then  $\mu\text{V}$ -values are normally not interesting. Thus, when a range is defined, the value range is limited to 5 digits (from the range).  
Example: The range is  $\pm 10\text{ V}$   $\rightarrow$  xx,xxx
  - Value: 12.34 mV
  - Readout: 0.012 mV
- There is no conversion of the unit if the unit is expressed in quotation marks:
  - 0.2 kN  $\rightarrow$  200N
  - 0.2 "kN"  $\rightarrow$  0.2 kN
- If the range is not known, then a maximum of 4 decimal places are displayed:
  - 1.2345678 V  $\rightarrow$  1.2345 V
  - 0.1234567 V  $\rightarrow$  123.45 mV
- If no unit is defined, the exponent notation is no longer used:
  - 12345678  $\rightarrow$  1.2345
  - 0.0012345  $\rightarrow$  0.0012
  - 123456.78  $\rightarrow$  123456



## Input ranges rounded

Use of taring or the entering of a value for the "Sensitivity" easily cause the generation of input ranges having very many decimal places. In order to keep a good overview, the display of the input ranges is rounded off to 5 significant digits.

When different channels have very similar scaling, then multi-selection can be used to select a input range which, due to rounding, will now be displayed in the same way.

Parameter sets and channel parameters still retain the original value.



### Storage of measured data: Data volume reduced

The imc3-format's data volume has been substantially reduced for low sampling rates.

In the new imc3-format (under imc STUDIO 2022), data measured at a sampling rate of 20 Hz, for example, generated 16 times the data volume compared to the imc2-format (under imc STUDIO 5.2). High sampling rates were not as strongly affected.

**Background:**

Internally, a header is inserted into the file at regular intervals. This header ensures that the data captured up to the moment of the last header can be loaded, even if the file had not been closed correctly.

At low sampling rates, this header is entered too often. Now the system adapts to the sampling rate.

In consequence, the files are still larger than in imc2-format, but only slightly.



### Renaming Setup parameters

Some parameter names have been corrected:

Incorrect name - german	New name
Shunt Kalibrierwiderstand	Shunt Kalibrierwiderstand
Automatischer Filter-Faktor	Automatischer Filter-Faktor
Sensorversorgungs-Polarität	Sensorversorgungs-Polarität
Incorrect name - english	New name
sensitivity	sensitivity
associated	associated

See also the other renames on page "[Curve properties](#)"<sup>42</sup>.

**Notes on compatibility:**

When designations of parameters are changed, modifications are necessary if these parameters are used in a "Parameter set file". If you import existing parameter set files containing these parameters, please revise these files, replacing all instances of them using a text editor.

## 1.6.5 Inline Analysis - imc WAVE Vibration



### Human vibrations with more functions

"Human vibrations" has been renamed since more filters have been added. New name: "Filter rms".

Parameter	Description
Time-weighting	The parameter "Time-weighting" has been expanded: <ul style="list-style-type: none"> <li>• previously available selections: "F" (Fast), "S" (Slow)</li> <li>• newly added: "I" (Impulse), "Peak", "Leq from start" and "Leq in interval"</li> </ul>
Frequency-weighting	The parameter "Frequency-weighting" has been expanded: <ul style="list-style-type: none"> <li>• The filters "Low-pass", "High-pass", "Band-pass" and "Band-stop" have been added</li> </ul> If one of the filters is elected, it is possible to additionally set the following parameters: "Characteristic", "Order" and "Cutoff frequency".
Diff./Int.	New parameters: <ul style="list-style-type: none"> <li>• Differentiation and Integration "Diff./Int.".</li> </ul>

## 1.6.6 Panel and Widgets



### Automatic display range for Widgets

The Widgets apply the channel's measurement range as the display range. See the detailed description under "[General changes](#)"

#### Optimized scale range

The Widgets: "Potentiometer" and "Standard meter" have been improved

If the measurement range is specified by the variable, the Widget adjusts the edge-ticks in such a way as to display "optimum" numbers.

This is especially advantageous in cases of taring, when odd ranges occur.

**Example:** For a range of "-97...103", the scales are rounded up to "-100...120".

The count of decimal places is also automatically adjusted.

**Exception:** When the range is entered manually in the Widget, the exact values entered are used. The count of decimal places can then also be modified.



### Curve window colors on the dialog-page

The curve window colors can be configured differently for the display/operation pages and for the Report pages. Typically, the result should appear the same whether in the printout/PDF or in the monitor screen display.

For the printout/PDF-results of a dialog-page, however, the printer colors were used and not the monitor screen colors.

The colors are now used as follows:

Page	Colors
Dialog-page	<ul style="list-style-type: none"> <li>• on monitor screen: screen color</li> <li>• in the printout: <b>screen color</b></li> </ul>
Report-page	<ul style="list-style-type: none"> <li>• on monitor screen: printer color (The Report-page is designed for printout or PDF. Consequently, the printer colors are displayed here.)</li> <li>• in the printout: printer color</li> </ul>

**Notes on compatibility:**

This affects existing experiments. Since the correct colors are now used, the result of a printout can appear different.

### Curve window colors on the Report-page

When curve windows were copied from Dialog-pages to Report-pages, the colors usually were not suitable for a white Report-page.

New curve windows are set so that the global colors are used for the printout. Furthermore, the background is always white, even when a different color is set.

**Notes on compatibility:**

This does not affect existing curve windows. Their colors remain as they are.



### Widget "Level indicator" has clearer design

By means of the Widget, overmodulation of a channel is more quickly recognized. Toward this end, the color must provide an indication that overmodulation has occurred. To make this easier to recognize, the different colors for channels have been eliminated. This makes any overmodulation stand out more clearly.

Additionally, under each bar the associated channel name is displayed.

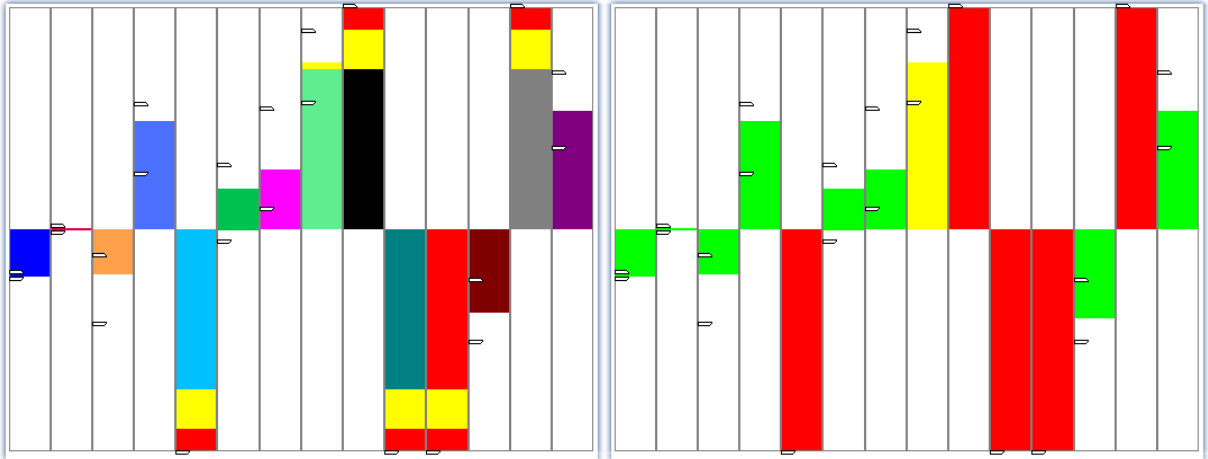

*At left the previous color profile - At right the new color profile  
Any overmodulation can be recognized immediately*

#### Notes on compatibility:

Any existing level indicators now apply the new design.

## 1.6.7 Variable management

### Complex variable types are supported

Complex data with

- Real- and Imaginary parts or
- Magnitude and Phase.

Segmented complex variables, e.g from the imc FAMOS-function [ComplexSpectrum](#) are still an exception.

### Time-stamped imc FAMOS-results are supported

With imc STUDIO, it is now possible to load time-stamped imc FAMOS-results, e.g. results from SearchLevel-calls.

## 1.6.8 imc STUDIO GoPro



imc STUDIO GoPro enables the capture of video data using the GoPro video camera.

The camera is connected via Bluetooth and WLAN with the controlling PC on which imc STUDIO is running.

The GoPro-plugin includes a remote control mechanism for the camera. Video data from a GoPro and measurement data from imc measurement devices can be captured and saved simultaneously.

The video data are captured by the camera and saved in the camera. After conclusion of the measurement, the video file is downloaded automatically. This process often takes as much time as the capture itself.

During its capture, there is no live transmission of the video image. Only after the measurement is it possible to analyze the video (e.g. using imc FAMOS) in parallel with the measured data.

Since GoPro works independently, direct synchronization of the video data with the imc measurement device is not possible. There is always a small offset which varies with the particular measurement and camera type and which can not be determined automatically. For purposes of synchronizing the video data with the measured data, it is possible to use the imc FAMOS Video-Kit, for example.

For imc STUDIO GoPro, separate licensing is required accordingly.

## 1.6.9 Powertrain Monitoring



### Powertrain Monitoring again available

This component can be activated via the Product Configurator.

imc STUDIO Powertrain Monitoring has been developed in cooperation with the company **GfM (Gesellschaft für Maschinendiagnose mbH)** for power train diagnostics. For Powertrain Monitoring, an extra license is required, which is available from imc Test & Measurement GmbH. It can be combined and run with various baseline-editions of imc STUDIO.

## 1.6.10 Scripting / API



### The following new capabilities are available

- By means of Scripting and imc API, a imc Online FAMOS-source text can be imported/exported.
- By means of imc API, it is possible to request imc STUDIO-version information, as well as the installation and application folder paths.
- In the Scripting, access to logbook entries is now possible without calling the "GetAPI()" method. The class "LogbookEntry" is now available directly.

## 1.6.11 Performance



### Performance improvements and problem solutions

- High-speed TSA-data now require less CPU computational power.
- The continual increase of working memory demands along with increased channel count has been corrected.
- Curve window: Non-existent channels linked to a curve window caused substantial time demands upon selecting a measurement in the Data Browser, even though the curve window was linked with "Current Measurement" and no data were loaded.

### 1.6.12 imc STUDIO Monitor



The first version of imc STUDIO Monitor 2023 is available. See the separate document: "*What is new*" for imc STUDIO Monitor.

imc STUDIO Monitor is now a stand-alone product with separate licensing, and no longer a supplemental package for imc STUDIO Standard, Professional or Developer. Thus, in order to operate imc STUDIO Monitor no additional imc STUDIO license is required any longer.

Many functions have not yet been implemented and will undergo further development in subsequent versions.

**Currently available:**

- All channels/variables belonging to the selected device return data.
- The channels/variables can be dragged to the Panel and displayed there while the measurement runs.
- Values can be written to variables in imc STUDIO Monitor - e.g. Display-variables.
- The configuration can be saved/loaded.

**The following functions are not yet implemented:**

- Saving of the measured data.
- Reaction to changed device configuration: When the configuration is changed in imc STUDIO, the device must be re-selected in imc STUDIO Monitor.
- Views adapted to imc STUDIO Monitor: At this time, all views available in imc STUDIO are used.

### 1.6.13 Miscellaneous optimization

Alongside minor bug fixes, the following important improvements have also been implemented:

Area	Description
Fieldbus-channels	When the Fieldbus-channels were captured as xy-data sets, the circular buffer for data display was sometimes not calculated correctly. Once the circular buffer was full, it was completely emptied. The circular buffer is now again correctly filled according to the FIFO method.
Setup - device control	<ul style="list-style-type: none"> <li>• The display of Current values failed to display any values in various cases, or stopped updating the values.</li> <li>• When transferring the device configuration to a different device, the suggested address of the modules was offset by one address in some cases. Module number 0 should be Module number 1, and 1 should be 2 etc.</li> <li>• The metadata column "<i>Image</i>" no longer showed any preview in the table if an image was linked with it.</li> <li>• When the properties for either the module or the device were open while the device was connected, then various error profiles appeared upon closing the dialog.                             <ul style="list-style-type: none"> <li>• The software version of the device does not match that of the PC!</li> <li>• Data storage error in imc Online FAMOS.</li> <li>• The device is not parameterized.</li> </ul> </li> </ul>



Area	Description
Data type: Reduced-data channels	<p>Reduced data channels, such as the results of the function "TransRec" or DI-port-compressed channels, can not be used in imc STUDIO. For this reason, the following modifications have been made:</p> <ul style="list-style-type: none"> <li>• imc Online FAMOS-results of the function "TransRec" and DI-port-compressed channels are blocked from transfer to the PC.</li> <li>• When loading an old experiment with the affected channels, a message is posted which indicates that transfer to the PC is not possible.</li> <li>• The function "TransRec" is no longer offered in imc Inline FAMOS.</li> </ul>
Data storage of imc Inline FAMOS-channels	<p>"Save trigger events in individual files": A triggered, calculated imc Inline FAMOS-channel was incorrectly saved. Each event was assigned a new measurement folder with the extension .002/.003/...</p> <p>Now, as with other channels, a new trigger folder located under the measurement folder is used.</p>
imc Inline FAMOS	<ul style="list-style-type: none"> <li>• After loading an experiments from Version 5.2, an imc Inline FAMOS-task would not recognize its own virtual channels. It was necessary to perform "Apply" to the source text one single time.</li> <li>• When the system detected a circular dependency among multiple imc Inline FAMOS-tasks, start of the measurement was not prevented. Now the start is again canceled if circular dependency is detected.</li> <li>• When the system detected a circular dependency among multiple imc Inline FAMOS-tasks, a pertinent message is posted. This message now provides information on which task and which channel is affected.</li> <li>• imc Inline FAMOS occasionally started with a delay of 0.2 s to 1 s after start of the device.</li> <li>• When comparing channel values with one value by means of the "Equal"-function, it returned incorrect results. The result varied between 0 and 1072693248, even though it should have been 1.</li> <li>• imc STUDIO crashes when the following settings have been made: <ul style="list-style-type: none"> <li>• in imc Inline FAMOS, a virtual channel is created using "CreateVChannel"</li> <li>• the value for "CreateVChannel" is read from a pv-variable which had been created in imc Online FAMOS.</li> </ul> </li> </ul>
imc Inline FAMOS and imc Online FAMOS	<p>Previously, when values were written to static vector elements in the OnInitAll, OnMeasureStart or OnMeasureEnd blocks, the calls were ignored and not executed. Now, pertinent error messages are posted, since the system's ignoring of the situation had caused irritation for users.</p> <p>The same applies when calling the functions SingleValueChannels or VectorChannelSet in these control commands.</p>
Data Processing	<p>Directly after loading an experiment, there were no Data Processing-channels presented in the Data Browser. They were only presented once the action "Prepare", was performed, for example.</p> <p>Among other things, Data Processing-channels can be channels of results from imc Inline FAMOS, Inline Analysis and Bus Decoder. Now these channels are present directly upon loading the experiment.</p>
Automation	<ul style="list-style-type: none"> <li>• When an error was detected upon processing the configuration for a Automation task, the bug location was no longer indicated in the Editor.</li> <li>• imc Online FAMOS did not accept pv-variables as a vector-index. Thus it was not possible to use any loops having persistent counters in the Automation.</li> </ul>

Area	Description
Panel	<ul style="list-style-type: none"> <li>Panel pages could not be exported to the Clipboard via the context men.</li> <li>Accommodating the Panel page to the available window size has been improved. The page is still exactly as large after modification as a new page. Previously, depending on the resolution it could be either too small or too large. When multiple monitors were used, the resolution of the main monitor was used for the purpose of determining the target size. Now, the system correctly uses the resolution of the monitor on which the page is displayed.</li> </ul>
Widgets	<p>Widget Table:</p> <ul style="list-style-type: none"> <li>When the "<i>Checkbox</i>" was activated as the Editor in cells, the checkbox in the cell was displayed incorrectly: the checkbox was on the right side of the cell and on the left the value was still displayed additionally. Now only the checkbox is displayed, in the center of the cell.</li> </ul> <p>Curve window display in the "<i>Table</i>"-format:</p> <ul style="list-style-type: none"> <li>The table no longer scrolled automatically to the new value.</li> </ul>
Tool window selection	In the expanded view of the dialog " <i>Tool window chooser</i> ", some entries had no names.
Project management	<ul style="list-style-type: none"> <li>Import of project-export-files from Version 5.2 - The measured data were not found, <ul style="list-style-type: none"> <li>when a dot was present in the project name or</li> <li>when the project was renamed upon importing.</li> </ul> </li> <li>When a project is imported, the experiment templates are also converted. For this reason, when a new experiment is created, there is no longer any notification that the experiment originates from an old version of imc STUDIO.</li> <li>When an experiment is transferred to a different device, the newly created experiment is now set up in the project in which the original experiment is located.</li> </ul>
Variable management	<ul style="list-style-type: none"> <li>Variables created by means of "<i>Load variable</i>" returned an error message if a different experiment was loaded or a new one was created.</li> <li>The variables "<i>Disk size</i>" and "<i>Free memory</i>" always returned the value 0 bytes. The free memory space and the size of the storage medium are now displayed again.</li> </ul>
Commands	<p>Set variables:</p> <ul style="list-style-type: none"> <li>When a space or tab-character appeared after the number in the column of values to set, an error was reported. Now these characters are ignored again, as in Version 5.2.</li> </ul> <p>imc FAMOS command</p> <ul style="list-style-type: none"> <li>When opening imc FAMOS via the dialog, the values of integer pv-variables were not passed. Now, the variables take the correct value.</li> </ul>
User-defined events	In some cases, user-defined events would no longer trigger after having been triggered multiple times.
Performance	<ul style="list-style-type: none"> <li>The required volume of private memory for the time-stamped CAN-Fieldbus data has been optimized. There is no longer any continual increase.</li> <li>Automation: The event "<i>imc FAMOS Automation Data Cutting</i>" caused very high demands on the CPU.</li> </ul>
Deinstallation	Deinstallation failed to remove the imc STUDIO symbol from the desktop, as well as all the entries in the Start Menu.
API	In the API, a collection of constants is now available for default responses to dialogs (UserRequest).

## 1.7 Update-notes and compatibility from 2022 to 2023

If you plan to update from Version 2022 to 2023, there are a few things which you may need to observe regarding any existing databases. In particular, be aware of the following points:

Area	Function
Setup	Certain <a href="#">parameter-names</a> <sup>[42]</sup> on the dialog: " <i>Curve properties</i> " have been modified.
Widgets	<ul style="list-style-type: none"> <li>Modification is necessary if the display range of a Widget already used a <a href="#">channel's measurement range</a> <sup>[42]</sup> as the range boundaries for the scales.</li> <li>The colors of the <a href="#">level indicator</a> <sup>[54]</sup> have been revised.</li> </ul>
Panel	Upon <a href="#">exporting Dialog-pages</a> <sup>[53]</sup> , the curve windows now use the screen colors and no longer the printer colors.
Reduced data channels	Modified treatment of <a href="#">reduced data channels</a> <sup>[57]</sup> , such as the results of the function " <i>TransRec</i> " or DI-Port compressed channels.
Sequencer	Discontinued: Sequencer command " <a href="#">Transfer device settings</a> " <sup>[40]</sup>
imc EOS	It is not possible to load the device configuration of imc EOS devices from version 2022 into version 2023. When an experiment containing an imc EOS device is loaded with imc STUDIO, the system automatically de-selects that imc EOS device. In such cases, the device needs to be re-selected (manually) and a new configuration must be created for it.

### ! Notes

### Update from Version 5.2

If you perform an update from Version 5.2, please also observe

- the [update notes on version 2022](#) <sup>[109]</sup> and
- the [the missing components and functions to version 5.2](#) <sup>[12]</sup>.

## 2 imc STUDIO 2022

### 2.1 Introduction

The imc STUDIO 2022 you now possess is a version which is updated to the newest level of PC technology. This version of imc STUDIO is designed for 64-bit computer architecture. For this purpose, many key components have been updated, revised or even redesigned from scratch. We have invested much time in improving functions, simplifying workflow procedures and achieving greater system stability. The outcome is a modernized system architecture which provides substantial improvement of performance. To mention a few points up front:

- imc STUDIO is now a multi-threading capable 64-bit version,
- thanks to the new device firmware imc DEVICEcore, communication with and control of the new devices such as imc EOS is many times faster.
- the display in the curve window is substantially more powerful and smooth.
- ...

On the following pages, you will find an exact enumeration and description of the changes. There you may find quite a lot which will be pertinent to your work.

In particular, you should read the chapter "[Update-notes and compatibility](#)" <sup>[109]</sup> before performing the update. It presents all the functional changes and modifications which need to be observed when updating.

The imc team wishes you total success in accomplishing your measurement tasks with imc STUDIO.

## 2.2 imc STUDIO 2022 R3

### 2.2.1 General Changes in imc STUDIO



#### Accessible introduction via the homepage

It is now possible to obtain tutorials and the manuals for the system directly from the homepage. This makes quick familiarization with the system easier to find.

As well, the manuals for the hardware and other imc-products are available directly on the homepage.



#### Personal metadata in the Experiment/Meta-folder

For the purpose of saving your own personal files pertaining to the experiment, the folder "*Meta*" can be used. Previously this had been a rather hidden feature, since this folder need to have been created first. Now, the "*Meta*"-folder is automatically created in the Experiment when "*Save*" is performed or when creating an experiment using "*New*", unless this folder already exists. Along with this, a *readme.txt* file is also created, which describes the folder's function.

As previously, the folder is always exported along with the experiment. What is new is that it is also imported even when no measured data are imported. Previously the folder was only imported when the measured data were also included in the import.

For example, it is possible by this method to save characteristic curves, target value tables, CCV-files or reference data, for instance for the ChannelLoader .



#### Selecting the data format: imc2 or imc3

By default, imc STUDIO saved the measured data in the imc3 format. In imc FAMOS, it is possible to set whether to save the files in either the old imc2 or the new imc3 format. imc STUDIO now also applies this setting. We continue to recommend saving the measured data in the imc3 format.

#### With which version and which device were the measured data generated?

The saved measurement files record with which version of imc STUDIO and with which firmware/3rd-party device/DataProcessing and which device the measurement was performed. For this purpose, the \*.raw-file can be opened with a text editor. This info is readable whichever data format (imc2 or imc3) is used.

## 2.2.2 Setup and Device Control



### Display of instantaneous values for 3rd-party channels, incremental counters, device-variables etc.

The display of instantaneous values in the Setup now also includes indication of the current readings of the following devices/channel types:

- incremental counter inputs, fieldbus channels, FunctionSimulator-channels, Application module-channels, GPS-channels
- pv-variables, display variables
- ethernet-bits, virtual bits

The current reading is displayed as long as the channel is returning measured data. If the measurement is not running, the last reading is retained and displayed in gray font. This makes it clearly distinguishable which value is still being updated and which value may be obsolete.

Exception: For channels having an associated pv-variable (e.g. analog channels or incremental counter inputs), the following still applies:



- The current value is displayed as soon as the action "Prepare" is performed (so also before and after the measurement).

Name	Status	Current value	Measurement mode
<b>Channel type: Analog inputs</b>			
Channel_001	Active	0.00951138 V	DC - Linear
sin3	Active	-0.00536171 V	
<b>Channel type: Digital inputs / outputs (bits)</b>			
<b>Channel type: Digital inputs / outputs (ports)</b>			
DOut001		0	
DIn002	Active	0	Sampling
<b>Channel type: Display variables</b>			
DisplayVar_01		12	
DisplayVar_02		123	
.....		0	
<b>Channel type: Incremental counter inputs</b>			
Counter_001	Active	0 m	Distance (diff.)
<b>Channel type: Monitor: Analog inputs</b>			
<b>Channel type: Process vector variables</b>			
pv.Counter_001	Active	0 m	
pv.DIn002	Active	0	
pv.Channel_001	Active	0.0080495 V	
<b>Channel type: Virtual bits</b>			

Display of instantaneous values for various channel types

### 2.2.3 Firmware and new hardware

This imc STUDIO version has been released along with the following firmware and devices driver packages:

- [Firmware imc DEVICES 2.15 R3](#) 
- [Firmware imc DEVICEcore 3.5 R2](#) 

#### 2.2.3.1 Firmware imc DEVICES 2.15 R3

Alongside minor bug fixes, the following important improvements have also been implemented:

Area	Description
CAN-Assistant	<ul style="list-style-type: none"> <li>• The system's behavior when importing CBA-files having more than one node has been improved. The settings can be loaded to the selected node individually.</li> <li>• In the CAN-Assistant, pv-variables generated by other fieldbusses such as LIN are now also available as send-channels.</li> </ul> <p>OBD2-ECU Protocol</p> <ul style="list-style-type: none"> <li>• In the CAN-Assistants, additional PIDs conforming to the standard SAE J 1979DA:2021-04-21 have been implemented for the OBD2-ECU protocol.</li> <li>• In the CAN-Assistant, it is now possible to enter user-defined PIDs with the OBD2-ECU protocol.</li> <li>• The graphical illustration of the message mapping has been improved. With a message length of more than 8 bytes, the first 8 bytes are displayed correctly.</li> </ul> <p>CAN-Assistant - A2L</p> <ul style="list-style-type: none"> <li>• In some circumstance, after importing an A2L, the CAN-Assistant could display duplicates of an event. This was reported as an error upon running the syntax check.</li> <li>• When importing A2L files, it was only possible to search for labels in the A2L import dialog a few times. After that, the list of labels remained empty.</li> </ul>
CAN- and XCPoE-Assistant	In the CAN- and XCPoE-Assistant, the maximum count of events and DAQ-lists supported has been increased to 40.
CAN-FD interface with imc CRONOScompact device	Performance improvements regarding the CAN-FD-interface, which reduce demands on the system.
imc Online FAMOS	The syntax check which runs upon reading values from a CAN-message has been optimized.
CRONOS-PL\DIOINC CRONOS-PL\ENC-4	With the DIOINC- and ENC-4 boards of the imc CRONOS-PL device family, in the mode "Angle (abs)", the angle was indicated incorrectly, since the scaling "Imp/revolution" was not calculated correctly.
CRFX\HISO-8	At slow sampling rates (below 2 Hz), incorrect offsets were generated in 16-bit mode.

#### 2.2.3.2 Firmware imc DEVICEcore 3.5 R2

Alongside minor bug fixes, the following important improvements have also been implemented:

Area	Description
Calibration date	The calibration date is now displayed correctly for imc EOS-devices.
Data saving	Renamed channel names were not always correctly allied in the filename.
Synchronization	<p>The synchronization status was not reset correctly if one of the following occurred after successful synchronization:</p> <ul style="list-style-type: none"> <li>• the connection to the device was disconnected, or</li> <li>• a new experiment involving the same devices was set up.</li> </ul>

## 2.2.4 3rd-party devices



### fos4X - Data storage of the fos4X-channels has been revised

Previous behavior:

fos4X-channels were previously saved as equidistantly sampled channels. The time stamp of the first sample returned was used as the starting time. The time stamps of any subsequent samples were ignored since it was assumed that the samples would arrive at the specified sampling rate.

This mode is now replaced with two new procedures. You can now **toggle** between **time-stamped data** and **equidistant data** (resampled).

Background:

With long-duration measurements, it can occur that the data do not arrive at exactly this rate. Deviations by as much as 0.01 per mil have been observed. This produces noticeable effects when the measurement duration is long. For this reason, the exact time stamp is important.

If you record data with "Time stamp", it is possible to obtain an equidistant channel by resampling with imc FAMOS, for instance, during post-processing after the measurement.

In order to avoid needing resampling, the mode "Sampling rate" is provided. Here imc STUDIO performs the resampling directly during the data are recording. This compensates for the possible slightly deviating sampling rate.

#### X-axis: Time stamp

- The time stamps provided by the 3rd-party fos4X device are saved. The measurement duration of time-stamped channels is limited to 800 days. Additionally, they require more memory space. The precision of a time stamp is 256 ns.
- The sampling rate set is also required for sending the requests to the fos4X-device. This is the rate at which you want to receive the data.

#### X-axis: Sampling rate (equidistant data)

- The data stream starts at the next full second on the clock after arrival of the first sample. The system performs linear interpolation between the values returned at the sampling rate specified. Adjacent to any error fallback values, calculation of the interpolation applies the error fallback value.

Example with exaggerated offset to illustrate:

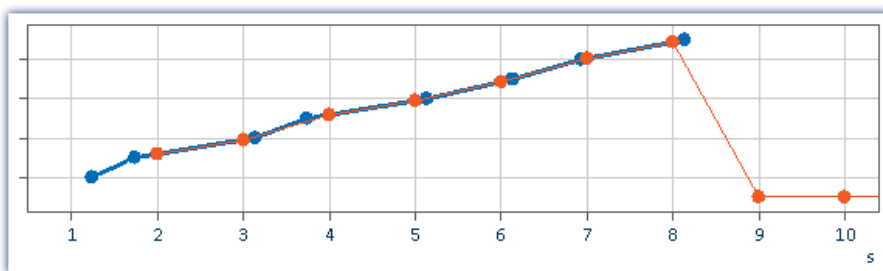

Parameter "X-axis" set to Time stamped (blue) or Sampling rate (orange)  
Values at 9 s and 10 s: error fallback values

### fos4X-data with time zone information

fos4X-data are now supplied with the information that they have been recorded in UTC. This ensures that the data are displayed stacked at correct reference to time in mixed operation with imc DEVICES- or imc DEVICEcore-devices, and thus can be subjected jointly to calculations.



### The 3rd-party device "*FunctionSimulator*" can be used in all editions

The 3rd-party device "*FunctionSimulator*" is now available in two variants. On the one hand as a template, as previously also for editing and with a corresponding license. And on the other hand as a complete 3rd-party device, which can now be freely activated in all editions.

The "*FunctionSimulator*" is a device which simulated various kinds of mathematics functions, including Sine, Cosine, Triangle, Sawtooth and Squarewave. The "*FunctionSimulators*" channels appear on the Setup page under "*Analog channels*".

Name	Connector	Status
<b>Channel type: Analog inputs (Count=8)</b>		
Cosine	cos	Active
DC	dc	Active
Noise	noi	Active
Rectangle	rect	Active
Sawtooth	saw	Active
Sine	sin	Active
Trapeze	tra	Active
Triangle	tri	Active

Setup: *FunctionSimulator* (Analog channels)

The frequency, scaling or offset can be user-specified.

#### Notes on compatibility:

The template has been renamed and is now called: "*FunctionSimulatorTemplate*". The new 3rd-party device has the name of the former template: "*FunctionSimulator*".

If the old template is already in use, it is possible to continue using it. In order to use the new 3rd-party device, please first delete the old template by means of the "*3rd party device management*".



### The 3rd-party device "*ChannellLoader*" provides information on the expected path of the missing data

If the file to be played back is missing, an error message now appears which provides the expected path and filename of the missing file.

#### The 3rd-party device "*ChannellLoader*" uses experiment-specific files

When a file is selected which is located below the Experiment-folder, the location is saved in "relative" terms with respect to the experiment. If the location of the experiment changes, the file will still be found as long as it is also in the new experiment. The file from the old experiment-folder is not us.

**Example:** You create a dat-file in the "*Meta*"-folder. If you now export the experiment and import it to a different device or under a new name, the "*Meta*"-folder is also present there (together with the dat-file). By means of the relative path, the copied dat-file is found and used.

**Note:** Other folder names can also be used. The advantage of the "*Meta*"-folder is that it is automatically included with the export or import. As well, it is included when copying with "*Save as*".

Whether the path is saved in relative or absolute terms depends on the relationship to the Experiment-folder. If the file is below the Experiment-folder, the path is "relative". If the file is outside of the Experiment-folder, the path is "absolute".



## 2.2.5 Inline Analysis - Overmodulation

Monitoring the overmodulation of "analog channels" (violations of the specified measurement range) as per the standard: "DIN EN 61672-1".

For purposes of display and evaluation of the overmodulation a variable is provided: "WAVE\_OverloadVariable". It indicates that one measurement channel is reporting overmodulation but not which channel.

When overmodulation is detected, then for **one second** the variable "WAVE\_OverloadVariable" takes the value "1". After that one second the system checks whether the overmodulation is still happening.

- if "no", the variable reverts to "0".
- if "yes", the value "1" is retained until there is no more overmodulation. Then the variable reverts to "0".

The following channels are monitored: active analog channels belonging to the firmware groups A and B (imc DEVICES and imc DEVICEcore), which are subjected **to calculations in an Inline Analysis** function. No other channels such as incremental counters or 3rd-party device channels.

## 2.2.6 Miscellaneous optimization

Alongside minor bug fixes, the following important improvements have also been implemented:

Area	Description
Widgets	<ul style="list-style-type: none"> <li>• The pushbutton (Designer) appeared like an Automotive-pushbutton. The property "Background" was initially set incorrectly.</li> <li>• Widget: "Execute menu action": Executing the menu action via the Widget did not work directly after the configuration.</li> <li>• DIO (Designer): The width of the Widget was too small so that after having been created, the font could not be displayed completely.</li> <li>• Table: When a "Range" was set for a cell, e.g. "0; 10", an object reference error was raised.</li> <li>• Table: PDF-export - The values displayed in a table do not contain up-to-date values if the table was not visible at the time at which export was performed.</li> </ul>
Kurvenfenster	<ul style="list-style-type: none"> <li>• Absent channels in the curve window cause very high demands on the CPU.</li> <li>• Load on demand: Supposing two channels are configured in the curve window for xy-display and display the saved measurements according to their measurement number. Previously, the data were not automatically loaded when a measurement was selected. They needed to be loaded manually. Now, channels which are displayed as xy channels are also loaded automatically.</li> <li>• The order of the channels in the free-floating curve window was mixed up when multiple channels were displayed simultaneously.</li> <li>• Shifting effects occasionally occurred in the display when other Widgets were present along with a curve window. The curves were then distorted at the height of the upper/lower edge of the other Widget.</li> <li>• Curve window selection: The list of curve window display variants has been revised.               <ul style="list-style-type: none"> <li>○ Changes:                   <ul style="list-style-type: none"> <li>"Standard maximized" has been eliminated</li> <li>"Polar plot" has been added</li> </ul> </li> <li>○ Renaming:                   <ul style="list-style-type: none"> <li>"Last value as number" renamed to "Numeric"</li> <li>"Waterfall diagram" renamed to "Waterfall"</li> </ul> </li> </ul> </li> </ul>
Panel	<p>When a page is locked, a padlock symbol appears. Outside of Design-mode it was too large and consequently made a scroll bar necessary in the Panel page.</p>

Area	Description
Rights management	The access privilege <i>"Exit fullscreen mode"</i> now prevents exiting of fullscreen mode even when it is set to <i>"hidden"</i> . <i>"hidden"</i> and <i>"disabled"</i> are now identical in behavior.
Setup - Performance and memory demands	<ul style="list-style-type: none"> <li>When changing a parameter of very many channels simultaneously by means of multi-selection, it took a long time until the change was applied. Now there is no longer any delay.</li> <li>Optimization of memory demands for time-stamped channels. Having many time-stamped channels caused data points to stop arriving in spite of a very low data rate.</li> </ul>
Setup - Device control	The action <i>"Prepare"</i> for the measurement reset the DOs to 0.
Setup - Firmware imc DEVICEcore	When the imcDevices2x-plugin was deactivated, the time zone information of the VRTC could no longer be obtained. In consequence, the start time for <i>"Automatic timed start"</i> , could be converted to UTC incorrectly for imc DEVICEcore-devices, for example.
Setup - Device-Assistants e.g. fieldbusses, OFA, ...	<ul style="list-style-type: none"> <li>The dropdown-box for device selection has been eliminated. Instead, all device tabs are displayed from the beginning.</li> <li>After clicking on the Exit-button within an embedded Assistant, the entire dialog for all devices closes.</li> <li>Minimizing an Assistant also minimizes imc STUDIO.</li> <li>Text improvements of the tool tips on the menu items for calling a device-Assistant.</li> <li>Saved fieldbus bits could often not be displayed in the curve window.</li> <li>When a channel name collision occurred, e.g. due to different device-Assistants, the error message which appears now specifies exactly which channels are affected and to which Assistant they belong.</li> <li>When the problem of duplicate channel names was resolved, then after <i>"Prepare"</i>, in some cases the error <i>"Variable "&lt;HWID&gt;" does not exist"</i>, would appear, even though all settings had been made correctly.</li> </ul>
Setup - FunctionSimulator	<ul style="list-style-type: none"> <li>In the FunctionSimulator, when one channel had a defined measurement duration, but others did not, then after elapse of the measurement duration the error message <i>"Error in WriteData (Result = OpenExpected)"</i> was posted cyclically.</li> <li>FunctionSimulator-script: In the build of 3PDI-templates, there was a warning due to the target platform (x86). The target platform has been modified for the templates. Manual installation of <i>".NET 4.8 SDK"</i> may be necessary.</li> </ul>
Setup - fos4X-Blackbird	<p>Entering sampling rates which are not supported caused incorrect statements in the saved data. For instance, if 20 Hz was entered, a corresponding message was posted in the logbook. The device would work correctly at 50 Hz, however 20 Hz was entered in the saved file.</p> <p>Now during <i>"Prepare"</i>, the value is automatically corrected and the new value also appears with the measured data.</p>
Setup - 3rd-party devices	For 3rd-party devices within the system, the display of the serial number and device specs has been revised to provide a uniform appearance and unique identification.
Bus Decoder	<ul style="list-style-type: none"> <li>When changing the fieldbus configuration and thus generating a new channel for the Bus Decoder, the Bus Decoder reported an error upon attempting to check the configuration.</li> <li>A CAN-protocol-channel containing digital channels incl. bits could not be extracted by Bus Decoder. Upon checking the configuration an error was reported: <i>"CAN_Messages_S1_K1: Error in Configure(): Invalid Blob."</i></li> </ul>



Area	Description
imc Inline FAMOS	<ul style="list-style-type: none"> <li>• Writing values to integer-pv-variables via imc Inline FAMOS caused the error: "<i>Error writing the single value!</i>"</li> <li>• Segmented results channels could not be subjected to further calculations in any other imc Inline FAMOS-task.</li> <li>• The measurement did not stop correctly when it was closed, during data saving and when imc Inline FAMOS-calculations were running.</li> <li>• Data storage: When the data stream is interrupted, e.g due to power outages, the files of measured data leave gaps. Event-based files are generated in consequence. Each event has a time-reference expressed as an X-offset (X0). In imc Inline FAMOS channels, this had not been set correctly and was always assigned the value "0".</li> <li>• Multiple data storage deletions closed - failure to perform appropriate cleanup upon accepting the source text entered.</li> </ul>
imc Online FAMOS and imc Inline FAMOS	<ul style="list-style-type: none"> <li>• The function "<i>RecordEvent</i>" generated either no units or incorrect ones along the time axis. Now "s" is displayed correctly in both cases.</li> <li>• The description of the function "<i>NOT</i>" has been expanded: Notes were added to indicate that applying the function to expressions such as in "If NOT( pv.x &gt; 0) = 0" does not return correct results.</li> </ul>
Data storage	<ul style="list-style-type: none"> <li>• It had not been possible to save more than 509 channels on the PC simultaneously. This limit has been eliminated so that from imc STUDIO's side there is no limitation on the channel count.</li> <li>• The offset for Y-data in XY-data was always set to 0. In consequence, for saved data of this type an incorrect amplitude was displayed in the curve window.</li> <li>• Fieldbus bits, e.g. CAN-fieldbus bits had no unit (s) along the time axis.</li> </ul>
Option: Storage location measurement data	<ul style="list-style-type: none"> <li>• When a valid base path for storage of measured data was entered, but which did not yet exist, the path was not created and start of the measurement was canceled. Now the folder is created whenever possible.</li> <li>• The placeholder &lt;STORAGE.MEASUREMENT&gt; returned an incorrect time.</li> </ul>
Automation	<ul style="list-style-type: none"> <li>• An error in the Automation-component caused unexpected error messages not directly traceable to the error. For instance, an error was reported according to which the ramp function only supports Integer values, even though the function correctly supported Integer values. This problem is fixed.</li> </ul> <p>Find and Replace:</p> <ul style="list-style-type: none"> <li>• Skipping to the search results no longer worked.</li> <li>• Replacing the search results only replaced a small number of search results.</li> </ul>
Inline Analysis	<ul style="list-style-type: none"> <li>• Deletion of Inline Analysis-functions has been revised. For instance, if the last Inline Analysis-function was deleted, no internal cleanup was performed. The calculations deleted in this way were still present upon the next start and returned data. Similar problems also occurred when deleting devices on whose channels calculations were performed. The functions had only been deleted from the tab "<i>Inline Analysis</i>".</li> <li>• The channels of the Inline Analysis-functions, based on imc Inline FAMOS-channels, were no longer listed after the action "<i>Prepare</i>".</li> <li>• The interplay between Inline Analysis and imc Inline FAMOS has been revised. In some setup combinations, errors regarding invalid trigger names were reported even though the configuration was correct.</li> </ul>

Area	Description
Commands	<p>imc FAMOS</p> <ul style="list-style-type: none"> <li>When a not (yet) existing variable was passed to imc FAMOS, a warning was posted. Normally this warning would not be desired because upon the first evaluation there would be no results channels, for example. Any results would only be available after the second evaluation. For this reason, no warning is now posted (this matches the behavior in Version 5).</li> <li>Each time the imc FAMOS-command transfers a result to imc STUDIO, as a result of which an existing variable was overwritten, the category of the variable was changed from "User-defined" to "imc FAMOS" or vice versa.</li> <li>By means of the imc FAMOS-command, a display variable is written which is then transferred via CAN. If the imc FAMOS-calculation returned the same value to which the display variable was already set, the value was not transferred correctly via CAN. Although the display variable had the correct value, CAN transferred a "0".</li> </ul> <p>User-defined characteristic curve</p> <ul style="list-style-type: none"> <li>With a default-value for "Delay" of "0.0", the command could not run. Previously, only whole numbers were allowed; now also decimal numbers are allowed, so that this default-value will be accepted.</li> </ul> <p>E-Mail</p> <ul style="list-style-type: none"> <li>Files were blocked if they were sent with the command "E-mail".</li> </ul>
Load Variable	<p>When an event-based channel is loaded for which the events have different specified sampling rates, import is now denied. These are not files which can be created in imc STUDIO or which imc STUDIO can handle. Previously, the channels would be imported, but then they would have incorrect axis settings.</p>
Scripting	<p>When creating new scripts, upon first compiling them warnings would be posted regarding a processor architecture conflict. Manual installation of ".NET 4.8 SDK" may be necessary.</p>
API	<ul style="list-style-type: none"> <li>In the API, the constructor has been revised so that the obsolete LicenseAccessKeys no longer can be passed.</li> <li>In the API-project, a line for the Assembly's search folder was missing.</li> </ul>
Installation medium	<p>imc FAMOS</p> <ul style="list-style-type: none"> <li>The new revision is included on the installation medium: imc FAMOS 2022 R3</li> </ul> <p>fos4X</p> <ul style="list-style-type: none"> <li>The file "fos4TV.exe" has been updated on the installation medium. All other files have been deleted and are available on the imc homepage.</li> </ul> <p>System</p> <ul style="list-style-type: none"> <li>OS-Update: In order to avoid any problems with obsolete signatures and security holes, the previous ".NET 4.8-Framework" has been updated on the installation medium.</li> </ul>
Installation	<p>Changes to the installation:</p> <ul style="list-style-type: none"> <li>When selecting the "Demo" installation variant, imc WAVE is now also selected and installed.</li> <li>Since "Shared" and "imc LICENSE Manager" can not be de-selected, they no longer appear in the list for product selection.</li> </ul>

## 2.3 imc STUDIO 2022 R2

### 2.3.1 Firmware and new hardware

This imc STUDIO version has been released along with the following firmware and devices driver packages:

- [Firmware imc DEVICES 2.15 R2](#) 
- [Firmware imc DEVICEcore 3.5 R1](#) 

#### 2.3.1.1 Firmware imc DEVICES 2.15 R2

Alongside minor bug fixes, the following important improvements have also been implemented:

Area	Description
CAN-Assistant	When importing .arxml files, when the messages' names were very long, the same new name was sometimes assigned to different messages.
XCPoE-Assistant	Opening the XCPoE Assistant raised an error.
Certificates	The installation contains a new certificate. Additionally, it is available for download on the homepage.  For transfer via secure https access, a certificate obtained along with the installation purchase. This certificate has an expiration and must be renewed annually.
WFT	<ul style="list-style-type: none"> <li>• Balancing via imc Online FAMOS: When performing balancing using the imc Online FAMOS function <a href="#">RunAutoBalance</a>, an internal data overflow occurred in imc Online FAMOS.</li> <li>• The balancing-interval now indicates the correct count of revolutions.</li> </ul>

#### 2.3.1.2 Firmware imc DEVICEcore 3.5 R1

Alongside minor bug fixes, the following important improvements have also been implemented:

Area	Description
Access to the internal data carrier	Access to the internal data carrier in the device has been modified. By default, the entry to make for the user is "imc", and the password to enter is the device's serial number.  This change was necessary because many companies had deactivated guest access without authentication as the default in their Windows OS.
Trigger	The trigger threshold was compared with the unscaled measurement range. When a factor/offset was entered, the system often incorrectly outputted that the trigger threshold was outside of the measurement range.

### 2.3.2 Setup and device control



#### Device control - Summary

A new Setup page named "Summary" has been added.

This page provides a quick overview of all active channels, the data storage status, and of the circular buffer time. Additionally, the page can be filled with any arbitrary choice of channel parameters, as accustomed.

Channel name	Connector	Channel status	Current value	Save (device)	Save (PC)	Circular buffer time (curve window)	Channel type
DIN002	[01] DIn02	Active		<input type="checkbox"/>	<input checked="" type="checkbox"/>	1 min	Digital inputs / outputs (ports)
▶ Channel_001	[01] IN01	Active		<input type="checkbox"/>	<input checked="" type="checkbox"/>	1 min	Analog inputs
Channel_002	[01] IN02	Active		<input type="checkbox"/>	<input checked="" type="checkbox"/>	1 min	Analog inputs
Channel_003	[01] IN03	Active		<input type="checkbox"/>	<input checked="" type="checkbox"/>	1 min	Analog inputs
Channel_004	[01] IN04	Active		<input type="checkbox"/>	<input checked="" type="checkbox"/>	1 min	Analog inputs
Channel_005	[01] IN05	Active		<input type="checkbox"/>	<input checked="" type="checkbox"/>	1 min	Analog inputs
Channel_006	[01] IN06	Active		<input type="checkbox"/>	<input checked="" type="checkbox"/>	1 min	Analog inputs
Channel_007	[01] IN07	Active		<input type="checkbox"/>	<input checked="" type="checkbox"/>	1 min	Analog inputs
Channel_008	[01] IN08	Active		<input type="checkbox"/>	<input checked="" type="checkbox"/>	1 min	Analog inputs
Mon_Chan_001	[01] MIN01	Active		<input type="checkbox"/>	<input type="checkbox"/>	1 h	Monitor: Analog inputs
Mon_Chan_002	[01] MIN02	Active		<input type="checkbox"/>	<input type="checkbox"/>	1 h	Monitor: Analog inputs
Mon_Chan_003	[01] MIN03	Active		<input type="checkbox"/>	<input type="checkbox"/>	1 h	Monitor: Analog inputs
Mon_Chan_004	[01] MIN04	Active		<input type="checkbox"/>	<input type="checkbox"/>	1 h	Monitor: Analog inputs
Counter_001	[02] CIN01	Active		<input type="checkbox"/>	<input checked="" type="checkbox"/>	1 min	Incremental counter inputs
Counter_002	[02] CIN02	Active		<input type="checkbox"/>	<input checked="" type="checkbox"/>	1 min	Incremental counter inputs

Summary - all active channels

By means of the grouping box at the top left, it is possible to use Drag&Drop to apply grouping to individual columns. Thus for instance, it would be possible to group channels according to whether or not their data are to be saved.

Channel name	Connector	Channel status	Circular buffer time (curve window)	Channel type
<b>Save (PC): False (Count=4)</b>				
Mon_Chan_001	[01] MIN01	Active	1 h	Monitor: Analog inputs
Mon_Chan_002	[01] MIN02	Active	1 h	Monitor: Analog inputs
Mon_Chan_003	[01] MIN03	Active	1 h	Monitor: Analog inputs
Mon_Chan_004	[01] MIN04	Active	1 h	Monitor: Analog inputs
<b>Save (PC): True (Count=11)</b>				
DIN002	[01] DIn02	Active	1 min	Digital inputs / outputs (ports)
▶ Channel_001	[01] IN01	Active	1 min	Analog inputs
Channel_002	[01] IN02	Active	1 min	Analog inputs
Channel_003	[01] IN03	Active	1 min	Analog inputs
Channel_004	[01] IN04	Active	1 min	Analog inputs
Channel_005	[01] IN05	Active	1 min	Analog inputs
Channel_006	[01] IN06	Active	1 min	Analog inputs
Channel_007	[01] IN07	Active	1 min	Analog inputs
Channel_008	[01] IN08	Active	1 min	Analog inputs
Counter_001	[02] CIN01	Active	1 min	Incremental counter inputs
Counter_002	[02] CIN02	Active	1 min	Incremental counter inputs

Summary - grouped according to data saving

**Info on compatibility:** existing views are not modified automatically.

This page is not automatically present in existing views, but it can be integrated into these. To do this, open the context menu over an existing tab title and select the item "*Insert complete layout*" > "*Summary*".

Additional changes in this context:

- Old pages having the name "*\*-Statistics*" have been eliminated (except for "*Module-Statistics*"). These are no longer needed.  
**Compatibility:** When an existing database is used, the pages remain present. But when the database is overhauled, the pages will no longer appear.
- The menu item "*Statistics*" has been eliminated since the new page is very conspicuous.

### 2.3.3 Inline Analysis - imc WAVE



#### Machine diagnosis

imc WAVE Vibration has been supplemented with the function: "*Machine diagnosis*" (in accordance with ISO 10816/20816).

#### Revision of the FFT-functions

Applicable to all Inline-analyses: "*Noise*", "*Vibration*", "*Rotation*" and "*Structure*"

##### Parameter changes:

- "*Bandwidth*" is hidden and instead "*Sampling rate*" is displayed
- "*Lines*" is hidden and instead "*Samples*" is displayed

Compatibility: The parameters are converted automatically. No modification of existing experiments is required.

##### New parameter: "*Result*"

Available choices: "*RMS*", "*RMS<sup>2</sup>*" and "*Peak*" (Amplitude)

Compatibility: Previously, "*RMS*" was the hidden default setting so that it is selected for any existing experiments. No modifications required.

##### New choice for parameter: "*Averaging*"

Available choices: "*none*", "*from start*", "*Number*"

New choice: "*Number*", "*from start*" has previously been named "*Leq from start*"

##### New parameter "*Avg.-type*"

Available choices: "*RMS*" (quadratic mean), "*Arithmetic mean*", "*Minimum*", "*Maximum*"

Compatibility: Previously, "*RMS*" was the hidden default setting so that it is selected for any existing experiments. No modifications required.

### 2.3.4 Panel and Widgets



#### Display in the curve window is substantially more powerful and smooth

The refresh rate of extensive data sets is now up to 500 times faster.

For instance, when zooming out or when sampling data at a high rate, there are very many samples in the visible region, so instead of the individual samples a reduced min/max-curve is displayed. This difference is not visually detectable. This functionality is already familiar from imc FAMOS and now also enabled for streaming data during measurement.

Prerequisite:

- equidistantly sampled channels, such as analog channels, ...
- the "symbols" for each data point may not be activated

#### Widget - Table (Automotive, Industrial, Designer)

The count of decimal places in conjunction with the factor has been revised. In this context, there have been a variety of changes and corrections:

- "Decimal places": "auto" has been renamed to "Automatic formatting".
- "Decimal places" offers a selection list: 0, 1, 2, 3, Automatic Formatting, Inherited from Column (only in the cell) - other numbers can be entered.
- For the property: "Decimal places", the functionality of: "Automatic formatting" has been re-defined. The value selected signifies that as many decimal places are displayed as needed to make up to 5 significant digits visible, including pre-decimal places.

Example value	0.001213141 V	0.0012 V
For the factor: "Automat..."	1.2131 mV	1.2 mV
For the factor: "micro"	1213.1 µV	1200 µV

- When the "Factor" is set to "Automatic formatting", then "Automatic formatting" is also always used for the count of decimal places, no matter what its actual setting is. For instance, if the "Factor" is inherited from the column and that column has "Automatic formatting", then any count of decimal places can appear there; the setting for the count is ignored.

#### Bug fix and compatibility:

When loading older experiments, the settings are corrected if

- the "Factor" had been set to "Automatic formatting" and
- the count of decimal places had been a fixed number

In this case, the count of decimal places is also set automatically to "Automatic formatting" in accordance with the new definition.

Bug fix: If "Decimal places" was set to "auto", then "one" decimal place was always shown. Now "auto" is no longer equivalent to "1". In some cases, this will cause the display of existing experiments to change. If this happens, change the setting for the count of decimal places if you wish to retain exactly one decimal place.



## 2.3.5 Miscellaneous optimization

Alongside minor bug fixes, the following important improvements have also been implemented:

Area	Description
Curve window	An embedded curve window was no longer refreshed smoothly if a free-floating curve window was displayed at the same time.
Widget - Table	<ul style="list-style-type: none"> <li>It was no longer possible to set the table's visibility in response to a variable's value. The table was always invisible if a variable was entered.</li> <li>Texts were no longer displayed: Values of text variables and contents of the property: "Text".</li> </ul>
imc FAMOS-Sequences	<p>imc STUDIO 2022 is still not able to handle all data formats which can be generated in imc FAMOS-sequences. E.g. complex data types with real- and imaginary parts, or magnitude and phase, or even xy-data sets.</p> <p>The debugging has progressed to the point that imc FAMOS-sequences which generate these data types can still be run. In the predecessor version, no variable was returned once any of these variable types was present at the end of the sequence.</p> <p>The data types still can not be returned to imc STUDIO.</p>
Modified data storage location for measurement data	With the modified data storage location for measurement data, a fallback-path has been established. If the target folder at the start of data recording is not accessible, the measured data are saved to the default folder. A corresponding message is posted in the logbook.
3rd- party device	Compatibility: The 3rd-party device " <i>Profinet-Sniffer</i> " has been discontinued and eliminated.
Profinet-IRT	Upon transfer to a different device, the Profinet-configuration went missing.
Profinet-Assistant	<p>When loading experiments, in some cases a warning was posted that a new version of an external editor (e.g. Profinet-Assistant) was available. However, updating was not possible.</p> <p>Now the editor used (Profinet-Assistant) is no longer saved with the experiment. Instead, the editor provided with the existing installation of imc STUDIO is always used.</p> <p>Upon first loading the experiment with the new version of imc STUDIO, the message is displayed again one single time. <b>The change takes effect upon saving</b>, so that the message is no longer displayed afterward.</p>
imc API	With the imc API, a theme name (including " <i>None</i> ") can be transferred to the constructor of the imc STUDIO-component. For " <i>None</i> ", the theme is not overwritten.
Views	<p>Previously, three pre-configured view came with the product. The view "<i>Compact</i>" has now been eliminated, so that only "<i>Standard</i>" and "<i>Complete</i>" are still present.</p> <p>These views will not be deleted from any existing databases. However, they will remain in their old condition. No new functions will be embedded there. Recommendation: delete the view "<i>Compact</i>" manually from the list.</p>
Installation	<ul style="list-style-type: none"> <li>imc WAVE 5.2 and imc WAVE 2022 can now be installed in parallel.</li> <li>The names of the installation variants have been changed to make them more unambiguous. <ul style="list-style-type: none"> <li>Installation variant "<i>Demo</i>" is now called "<i>Full functionality for 30-day demo</i>"</li> <li>Installation variant "<i>Auto</i>" is now called "<i>Typical functionality incl. imc STUDIO Professional</i>"</li> </ul> </li> </ul>

Area	Description
Security vulnerability from log4net	<p>The Assembly for Log4Net has been updated to Version 2.0.14.</p> <p>Note: There is no risk due to this security flaw when used in conjunction with imc STUDIO. Log4Net is used as an element of the scripting editor, so it is sporadically loaded and used. However, this scripting-editor is a programming tool for enhancing imc STUDIO with custom functionality. It is not a web-server or any similar mechanism running in the background, which could be induced by some external request to run malware (which is the problem arising from the log4j security flaw). Furthermore, the scripting-editor has no Administrator privileges. Thus, no malware could have any effects on the system beyond the effects produced by script you wrote yourself.</p> <p>For this reason, there is no cause for alarm in regard to any published version of imc STUDIO to date. In this version, the assembly has been updated.</p> <p> See also: <a href="https://github.com/advisories/GHSA-2cwj-8chv-9pp9">https://github.com/advisories/GHSA-2cwj-8chv-9pp9</a></p>

### 2.3.6 Update-notes and compatibility

If you plan to update from Version 2022 R1 to 2022 R2, there are a few things which you may need to observe regarding any existing databases. In particular, be aware of the following points:

Area	Function
<a href="#">Setup pages</a> <sup>71</sup>	Old pages having the name " <i>*-Statistics</i> " have been eliminated
<a href="#">Widget - Table</a> <sup>72</sup>	<ul style="list-style-type: none"> <li>Interplay between settings for "<i>Factor</i>" and "<i>Decimal places</i>" has been changed.</li> <li>Decimal place count: "<i>auto</i>" no longer equates to "1".</li> </ul>
Discontinued devices	3rd-party device " <a href="#">Profinet-Sniffer</a> " <sup>73</sup>

This information is also presented in the chapter about the update from Version 5.2 to 2022.

## 2.4 imc STUDIO 2022 R1

### 2.4.1 General Changes in imc STUDIO



#### 64 Bit

imc STUDIO 2022 has been completely converted to 64-bit and requires a 64-bit operating system.

Advantages:

- Thanks to 64-bit, additional PC-resources become available. Under some circumstances, the demands of imc STUDIO went to the limits of a 32-bit program.
- The file size for measured data and circular buffer memory is no longer limited to 2 GB (does not apply to data storage on devices belonging to the firmware group A "imc DEVICES").

#### The list of operating systems supported has been modified

##### Supported operating systems

Windows 10 64-bit

This enables us to adapt better to the currently prevalent operating systems. Older component such as those required for Windows 7/8 and 32-bit systems can be deleted, in order to de-clutter the system.



### Performance und parallelization

In a variety of applications, imc STUDIO 2022 offers smoother operation, particularly when using high channel counts. For this purpose, the capabilities provided by modern PCs in the areas of parallelization, multitasking and multi-threading are rigorously exploited. imc STUDIO is thus able to utilize the available PC resources in a more dynamic and comprehensive way. Additionally, the performance in the setup is significantly increased. This particularly applies to the selection of devices (adding devices to the measurement setup), and to the saving and loading of experiments.



### Use of the new data format

The new imc data format (*imc3*) is now supported, applied and generated.

One major advantage of this format is the display of large data volumes in the curve window. It is no longer necessary to load large data volumes completely before they can be viewed. Instead, only so much data are loaded for the curve window as can also be displayed. In this way, you are able to quickly scroll and zoom, no matter how large the volume of data is.

Storage of the data is resilient to interruptions; even incomplete files can be used without the need for repairs. Furthermore, it is possible to save the imc EOS Monitor channels in the envelope curve format in which they are generated.

The prerequisite for loading the files generated is imc FAMOS 2021.



### Uniform default file paths

The respective default paths for the various imc-programs have been grouped together under "C:\Users\Public\Documents\imc". Thus they are no longer scattered either directly under "Public Documents", in their own "Documents" or any other paths. Exception: The imc STUDIO / imc WAVE database.

This does not affect update installations, which continue to use the previously specified paths.

## 2.4.2 Style

The user interface now features a new and improved design (device configuration pages, Logbook, progress indicators, options, menu ribbon, ...). The design elements are more flat and modern, the colors have been modified, some icons and dialogs have been revised... Some examples are stated below.



### Window arrangement and self-defined window compositions

You can display the tool window and main window on other pages. For instance, you can display the Data Browser in the window of the Automation. Or you can show the Panel in the Setup.

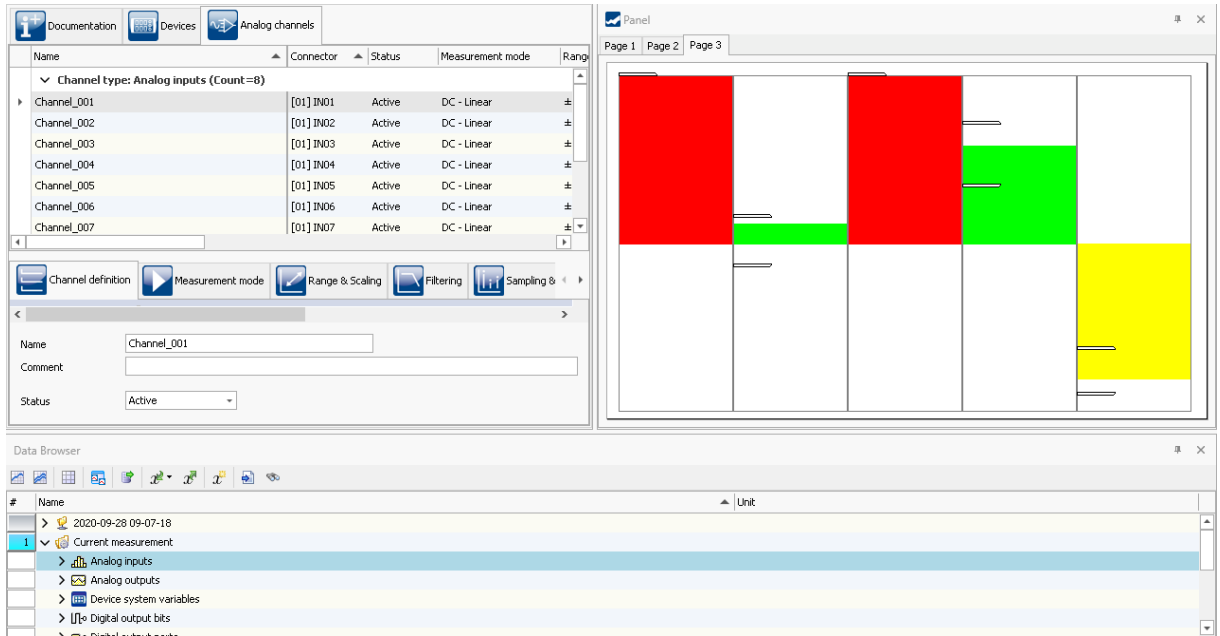

Example: Panel and Data Browser are displayed together in the main window "Setup".

### Views optimized for workflow

Certain small improvements provide assistance in reaching the right pages more quickly and getting a better overview. Thus for instance, in the "Compact" view, the Tab-bars are now always arranged at the top and no longer as previously with some below the contents. On the Channel Balance page as well, the tab bar is situated on the top in both the Standard and Complete Views.



### Collapsing the Logbook

The Logbook is provided with a button for collapsing it when it is not pinned. If the Logbook pops open to show a message, you can use this button to collapse it back out of sight.

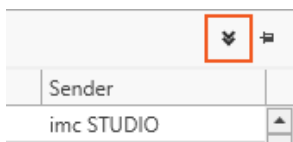

As previously, it still also automatically collapses when you take the focus away from it.



## Project management

The design of the Project Management dialogs has been made more lean. The internal project path and the Next- and Back-buttons have been removed, and the "Creation date"-column has been as well. It is possible to get this column back via the context menu.

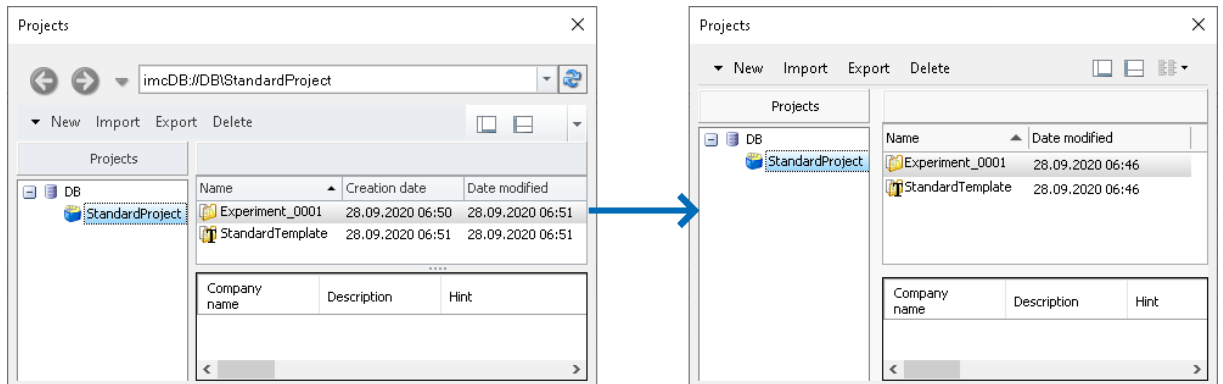

left: old dialog  
right: new dialog



## New menu ribbon icons or designation

Menu item		
	Connect	New icon
	Disconnect	New icon
	Panel Fullscreen	New icon and new name - Previously "Panel Fullscreen mode"
	Panel embedded	New icon and new name - Previously "Panel Embedded Mode"
	CAN	New icon
	Save current data	New name - Previously "Save current measurement data"
	Export current data	New name - Previously "Save current measurement data as"

Notes on compatibility: No modifications are necessary. Any menu actions which were used in the command: "Execute menu action" will continue to function as accustomed.



### Uniform terminology

Various display texts and terms have been revised and standardized; e.g. the term: "*Download*" has been renamed to "*Prepare*", and also the channel type designations at various locations have been standardized. Here are a few examples:

Old term	New term
Digital inputs	Digital inputs (ports)
Digital input bits	Digital inputs (bits)
Counter inputs	Incremental counter inputs
Net bits	Ethernet bits
Analog fieldbus channels	Fieldbus: Analog inputs
Digital fieldbus ports	Fieldbus: Digital inputs (ports)

Notes on compatibility regarding the channel types in Setup: See "[Setup and device control](#)"<sup>92</sup>



### New start menu icon

The start menu now presents large icons for imc STUDIO, Monitor and imc WAVE, equivalently to that for imc FAMOS, in conformity to the Windows 10 style.

## 2.4.3 Measurement management



### Placeholders - Path to the last measurement

For the purpose of recovering the path to the last measurement, a new dedicated placeholder is now provided.

<MEASUREMENTS["MEASUREMENT#LAST"].PATH>

This always will provide you with the path to the last measurement. The following placeholders have been implemented:

Placeholder	Description
<MEASUREMENTS["MEASUREMENT#LAST"].PATH>	Returns the data storage path to the measurement last saved.
<MEASUREMENTS["MEASUREMENT#LAST"].NAME>	Returns the name of the measurement last saved.
<MEASUREMENTS["MEASUREMENT#<Measurement number>"].PATH>	Returns the data storage path of the measurement having the respective measurement number; e.g., you can select a measurement in the Data Browser. For example, it can be assigned the number "1". You now have the ability to find the path to this measurement by means of the placeholder.
<MEASUREMENTS["MEASUREMENT#<Measurement number>"].NAME>	Returns the name of the measurement having the respective measurement number. For an example, see "PATH".
<MEASUREMENTS["<Measurement name>"].PATH>	Returns the data storage path of the measurement having the respective name.

Currently, you can't obtain the placeholder via the Placeholder-symbol, since there is no input support. Instead, use the context menu. In this menu, under "Measurement" there are various examples which you can select. Subsequently, you can modify the text according to your requirements.

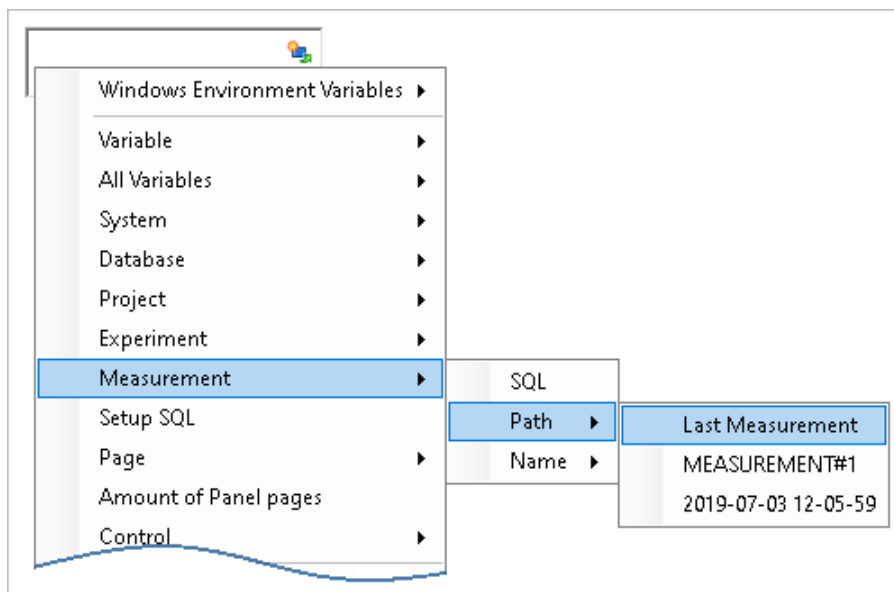

Creating the placeholder via the context menu

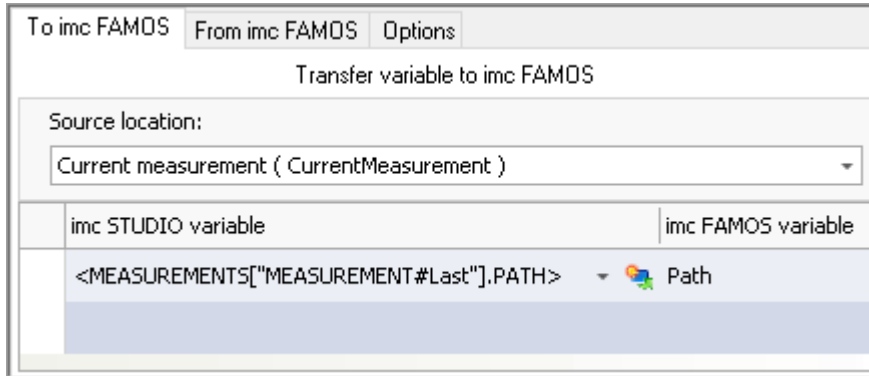

Example: Transferring the data storage path to imc FAMOS

The path to the last measurement saved remains known even when the experiment is re-loaded.

Special cases:

- If the last measurement is deleted, the last measurement performed before it becomes the last measurement.
- Measurement data folders created by different methods: In the Data Browser, only such folders are considered the "Last Measurement" if they were genuinely created by running a measurement. Whenever folders are created in a different way, e.g. imc FAMOS-events or by means of Scripting, etc., they are not treated as the "Last Measurement".
- Data storage using the menu item "Save current measured data": This is considered a measurement and can become the "Last Measurement".
- Subsequent adding of files: When imc FAMOS-results are saved to an already existing measurement, this does not count as a "new" "Last Measurement".



### Data Browser - Measurements can be viewed without being loaded

You are able to expand the entries of all measurements without needing to load the measurements first. The information on which channels belong to the measurement is also available before the measurement has been loaded.

### Automatic loading on demand - Only whatever is required is loaded

When the value of a variable belonging to a saved measurement is required, the entire measurement is no longer loaded; instead, each variable can be loaded individually. This provides advantages regarding speed: since only such variables are loaded which are really required, loading is significantly faster.

When does a variable get loaded? A variable is loaded automatically whenever the associated value is required; e.g. when the variable is displayed in a Widget or is used in a command.

The option for deactivating the function: "Automatic loading on demand", is no longer available.

### New events for the measurement management

Conclusion of measurement, new measurement, measurement deleted and measurement updated - see "[Events](#)"<sup>104</sup>

### Customized storage location for measurement data

The options belonging to the "Measurement storage area" have been renamed to "Storage location measurement data". Additionally, these options are no longer tied to the component "Project Management". They can now also be used if that component is deactivated.



## 2.4.4 Experiment- and Project Management

### Copying experiments to different projects

You are able to copy experiments to a different project. This can be done either by means of Drag&Drop or via the context menu. Doing this affects all files included in the experiment-folder: measured data, saved measurement settings, parameter set files or even personally created folders for metadata.

### Modifiable experiment template

When you create a new experiment, should a certain device already be selected? Do you use configurations or Setup pages which should already be available upon creation of the new experiment? This is all possible with the help of the experiment templates. The procedure for creating these templates has now been simplified. When you select the menu item "*Save as Template*", the current configuration is used as the basis for all subsequent new experiments.

When you click on the button, a new template is generated which the system then uses automatically (keyword "*Preferred experiment template*"). (from the edition "imc STUDIO Professional")

## 2.4.5 Firmware and new hardware

### ! Notes

#### imc DEVICES Firmware-Version as of 2.14

With this version of imc STUDIO, only imc DEVICES firmware versions as of 2.14 are supported. Please perform a firmware update of your devices in case these are still running version 2.13 or any older one. The firmware update from Versions 2.7 through 2.13 to Version 2.14/2.15 is free of charge.

This imc STUDIO version has been released along with the following firmware and devices driver packages:

- [Firmware imc DEVICES 2.15 R1 \(and 2.14\)](#) <sup>82</sup>
- [Firmware imc DEVICEScore 3.4 R2](#) <sup>86</sup>

### 2.4.5.1 Firmware imc DEVICES 2.15 R1 (and 2.14)



#### A time zone must be set

In order to make it possible to assign a time to measured data, the measurement can only be prepared when a time zone is set for every imc device used.

### Reference

Additional changes regarding the device configuration are noted in the section: "[Setup and Device Control](#)" <sup>87</sup>.

## Miscellaneous optimization

Alongside minor bug fixes, the following important improvements have also been implemented:

Area	Description
Clock change	Some devices have determined an incorrect date of the next day when: <ul style="list-style-type: none"> <li>• the time was adjusted in the last hour of the last day before switching to Daylight Saving Time.</li> <li>• the time was adjusted during the first hour of the day of the switch back to Standard Time.</li> </ul>
CAN assistant	<ul style="list-style-type: none"> <li>• In the CAN-Assistant, AUTOSAR (ARXML) import was conditional on enabling of the ECU-protocols. This is no longer applicable as long as no ECU protocols are imported by that means.</li> <li>• In devices of the types imc CRONOS and imc C-SERIES, assignments of CAN-process variables in sendable messages was lost upon closing the Assistant.</li> <li>• A2L-import: In some cases, the channel names are automatically modified upon import (e.g. if they are too long). In order to make the changes traceable, there is a new option: "<i>Save original name of imported channels in the channel comments</i>". If this option is activated, then upon import, each channel's name is additionally saved with the channel comment.</li> </ul>
imc Online FAMOS	<p>When a number with decimal places is assigned to an Integer variable, this is recognized as an error.</p> <pre>int var_int = 1.234</pre> <p>Thus, some possible causes of error are eliminated, since the data type is often not indicated by a variable's name. Assignments of Float variables to Integer variables remain possible, as previously, and do not require modifications.</p>
Flexray	<ul style="list-style-type: none"> <li>• ARXML-import: Import of AUTOSAR v4.3.1 has been implemented.</li> <li>• Import of Fibex files has been extended to Version 4.x.</li> </ul>

Area	Description
IWT-Fieldbus	The interface for the IWT-Fieldbus has been supplemented with some functions.
NMEA-compatibility	<p>Expansion of the NMEA-compatibility. The following NMEA Talker ID's are supported:</p> <ul style="list-style-type: none"> <li>• GA: Galileo Positioning System</li> <li>• GB: BeiDou (BDS) (China)</li> <li>• GI: NavIC (IRNSS) (India)</li> <li>• GL: GLONASS, according to IEC 61162-1</li> <li>• GN: Combination of multiple satellite systems (GNSS) (NMEA 1083)</li> <li>• GP: Global Positioning System (GPS)</li> <li>• GQ: QZSS regional GPS augmentation system (Japan)</li> </ul>
imc Online FAMOS	The function " <i>AudioBaordThirds</i> " is no longer provided in the Functions list. However, it can still be used.

## Hardware



CRFX EtherCAT Gateway

### imc CRONOSflex EtherCAT Gateway - At a glance

The imc CRONOSflex EtherCAT Gateway is a bus coupler that allows a number of imc CRONOSflex amplifier modules to be used within an EtherCAT-based automation or control system. imc amplifier components can thus be used in EtherCAT environments such as Beckhoff TwinCAT or MTS FlexTest, for example, without the need for a complete imc CRONOS data logger system (with base unit).

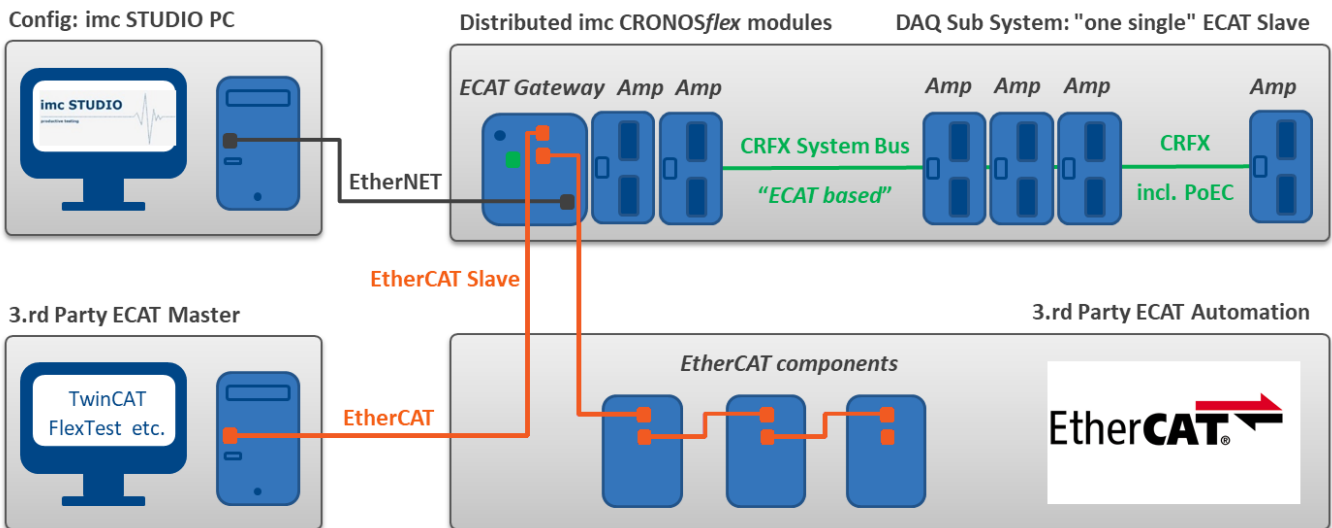

In connection with the gateway, the CRFX modules act as a data acquisition subsystem in the sense of an EtherCAT slave, without operating in the network of a complete imc CRONOS data logger. The individual modules are interconnected via the CRFX system bus. This imc CRONOS system bus is based on the "EtherCAT standard", uses network hardware and is spatially distributable via network cables (Power-over-EtherCAT). The protocol of the imc CRONOS system bus differs from the "EtherCAT Standard". It is not compatible with EtherCAT third-party systems, i.e. the CRFX modules cannot be operated in such an environment. The ECAT gateway establishes this connection, forming a single EtherCAT slave station.

Using imc STUDIO, the ECAT slave subsystem is configured on single time via EtherNET. Subsequently and in active operation, this access connection is no longer necessary.



### Compatibility: Discontinuation of imc devices belonging to groups 2 and 3

In conjunction with the new firmware, the following devices and device groups are no longer officially supported: All devices belonging to groups 2 and 3. This includes all devices having serial numbers 12xxxx (including imc CRPL, imc CRSL, imc C1, imc C-SERIES).

What needs to be observed when using the devices? We no longer test the new version on older devices. In consequence, new functions may not work with these devices. Additionally, error handling is not performed for the devices.

We assume that the devices will now continue to operate as before. However, we can not guarantee that this will continue to be the case with future version.

(For your information: this does not apply to the devices imc CRSL-N, imc C1-N/FD and imc C-SERIES-N/FD. Support of these devices continues; they can be identified by the serial numbers 14xxxx.)

Please contact our tech support if you have any questions.

### Compatibility: Discontinuation of imc HiL

Due to the discontinuation of imc HiL, the Setup page "*HiL + Application module*" has been renamed to "*Application module*". Additionally, the page has been assigned a new icon. (This change does not take effect on existing views)

## 2.4.5.2 Firmware imc DEVICEcore 3.4 R2

Our measurement device series imc CRONOS, which many customers have been using for over a decade for reliable recording and processing of multi-channel measurements at test stands or in mobile settings, has now been supplemented with a new generation of devices: imc EOS now breaks through to new dimensions of capability by providing channel data rates of up to 4 MHz.

For the configuration and control of the new measurement devices, a new driver package with new firmware is available: imc DEVICEcore.

You are able to operate devices belonging to both firmware groups in parallel and to configure them to jointly perform an imc STUDIO-experiment. Using imc DEVICEcore, you can communicate with and control the new devices at many times higher speed.

## Hardware



*imc EOS-U4*

### imc EOS - At a glance

- 4 MHz sampling rate per channel and device
- 1.8 MHz analog bandwidth
- 24 Bit A/D converter
- Wide measurement ranges: galvanically isolated precision measurement amplifiers for signals up to  $\pm 100$  V
- Safe data storage with integrated 1 TB flash memory
- Able to operate without PC
- Can be networked via Gigabit Ethernet
- Click connection: mechanically compatible with imc CRONOSflex
- Operates synchronously in conjunction with all imc measurement systems (via IRIG-B, NTP)
- Easy to use thanks to modern imc STUDIO/imc WAVE software, uniform for all imc systems

## High-speed measurement devices for the MHz range

imc EOS stands for speed! With sampling rates of up to 4 MHz, imc EOS allows the precise analysis of very fast dynamic processes. Voltage, current transducers and IEPE sensors for acceleration, sound or force can be measured at four isolated inputs.

Thanks to high-speed data acquisition technology and versatile measurement inputs, imc EOS is suitable for the analysis of very dynamic processes in material testing, vibration analysis and component testing. Along with crash tests, ballistics testing, pyro technics and blasting tests, typical application areas are rocket propulsion, turbines and jet engines. In automotive applications imc EOS is able to analyze fuel injection and ignition processes, acquire data on high-frequency vibration of motors, transmissions and suspension and investigate switching action and highly dynamic actuators. In the field of e-mobility, the system can be used for characterizing inverter-driven e-motors.

imc EOS systems can be operated with direct interactive PC control or as autarkic systems. The devices are equipped with integrated flash memory, allowing data storage of up to 1 TB independently of a PC. Networking imc EOS via Ethernet allows data transfer to a PC as well as archiving to Network Attached Storage (NAS).

imc EOS is compatible with all other imc data acquisition systems and can be operated synchronously with these systems in one single comprehensive measurement tasks. This is especially attractive for users who are already working with imc systems and wish to extend their existing equipment with high-speed channels.

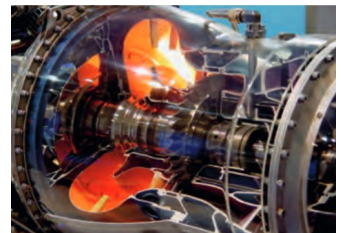

### 2.4.6 Setup and Device Control



#### Calibrating the amplifiers

At delivery, the amplifiers are freshly calibrated. Routine calibration ensures reliable measurement. Along with the information on the amplifier type, the calibration date is now also displayed. (This change does not take effect on existing views.)

If you have any questions about your measurement amplifier's calibration, please contact our tech support.



#### Reading out TEDS and defining the channel color directly at "Channel definition"

"Complete" view: There are now new parameters on the dialog "Analog channels" > "Channel definition": "Color" for the channel color in the curve window, and "Sensor" for reading out the information in TEDS. (This change does not take effect on existing views)



## Synchronization - NTP-settings parameters in the user interface

On the Setup page "Devices", the NTP-settings parameters listed below are available in the table description. Thus you can insert these into the table:

- Synchronization NTP server 1 and 2
- Synchronization NTP deviation time max.
- NTP synchronization interval
- Synchronization waiting time on self start max. (applies to all synchronization types)

In addition, an NTP tab for the configuration is displayed:

Storage	Synchronization	NTP	Timed start	Measurement options
NTP server (1)		<input type="text" value="0.0.0.0"/>		
NTP server (2)		<input type="text" value="0.0.0.0"/>		
NTP synchronization interval		<input type="text"/>		
NTP deviation time max.		<input type="text" value="0 ms"/>		



## Trigger - Trigger\_48 omitted from the user interface

Why is the trigger for starting measurements actually the last trigger?

"Trigger\_48" has been replaced by "BaseTrigger" and retains this permanent name. Wherever it is not required, it is hidden. For example, the BaseTrigger can no longer be displayed on the Setup page "Trigger".

Is there anything to be aware of when converting old experiments? No. The triggers are not renamed in existing experiments; they keep their names. Only newly selected devices obtain the new trigger name.

Notes: In imc Inline FAMOS, it will be possible to use both trigger names for the control commands. The only one which the system will still offer will be "BaseTrigger". However, if you load a source code having "Trigger\_48", this will also work.

### "1-Trigger" is now called "Immediate"

All channels which are not assigned to any other trigger start in response to the internal "BaseTrigger". The "BaseTrigger" previously was linked to the "1-Trigger". The new term for this mechanism is now "Immediate", since it starts the channels immediately.



## Interval data storage ignores the folder "Meta"

Interval data storage no longer deletes any existing folder having the name "Meta". If the count of intervals is limited, the metadata folders are successively deleted once the amount specified has been reached. The folder "Meta" is now ignored. This applies even if the folder contains measured data.

## Display of measured data and data storage upon re-connection

When imc STUDIO connects with a running measurement, no more event-based data are generated. A new measurement folder with a new time stamp is created. X0 (X-offset) is entered accordingly, so that the two measurement folders can be evaluated correctly even in the relative display mode.

If no gap in the data is detected (data overflow: e.g. RAM buffer time elapsed), the data in the RAM-buffer is read out. Even if imc STUDIO has closed in the meantime.





### Compatibility: Default values saved in the projects

The default values are now saved with the project. In this way, you can easily transfer the default values to other computers along with the project. Additionally, you can define varying default values for each project.

Previously, the default values were saved with the application and were applicable to all projects.

**Compatibility:** If your imc STUDIO 2022 installation is an update installation from Version  $\leq 5.2$ , then upon first starting, a message appears in the logbook. Please note the following:

- Upon installation, the default values are temporarily copied from the application settings of the older version to the application settings of the current version.
- After first starting, these are moved to the current project. After this, they no longer exist in the application.
- Be certain to save the project. Otherwise, the default values will be lost.
- If you use multiple projects, export the default values and import them to the projects in which they are to apply.

In the application settings for 5.2, the default values will continue to exist, if the version had not been uninstalled. There, you can still export the default values as accustomed.



### Compatibility: Uniform data storage and display within a measurement

The measured data are always displayed in the curve window in a representation having an X-offset (X0) "relative" to the time "0". (The following remarks do not pertain in the case of a "Pretrigger".)

- Upon start of the measurement, the X0 for all starting channels is set to 0.
- For a triggered channel, the point in time when the trigger releases is usually interesting. For that reason, the X0 is set to 0 for each trigger release. This means that each release is assigned a new "creation time".
- With interval saving, the measured data are regarded as "one" continuing measurement. Each time measurement resumes, X0 is increased proportionally to the point count of the running measurement. The "creation time" thus always remains the same. This means that the intervals can be viewed together, as in a continuous measurement.

So far, this matches the previous behavior.

However, the results of the function "Suspend / Resume data storage" had in the past deviated from this. In this case, it had depended on the channel type how the resumption was expressed in X0.

- Now, all channel types behave the same as for interval data saving. They are regarded as "one" continuing measurement. Each time measurement resumes, X0 is increased proportionally to the point count of the running measurement. The "creation time" thus always remains the same. This means that the saved data, as with interval data saving, are treated as one continuous measurement. Additionally, the relative x-coordinates of the saved data now also correspond to the data under "Current Measurement".

Among others, the equidistant channels such as the analog channels are affected by this change.

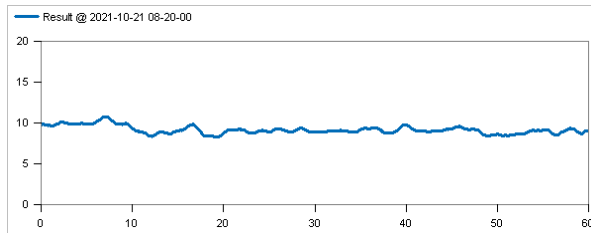

A measurement with continuous data saving

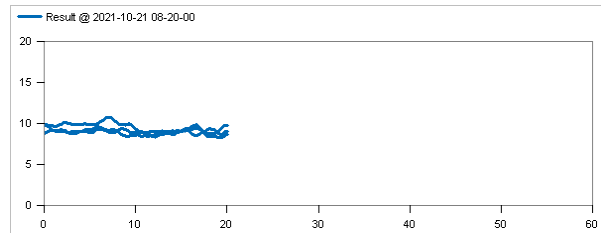

The channel has been triggered - X0 is reset to 0 upon each trigger release

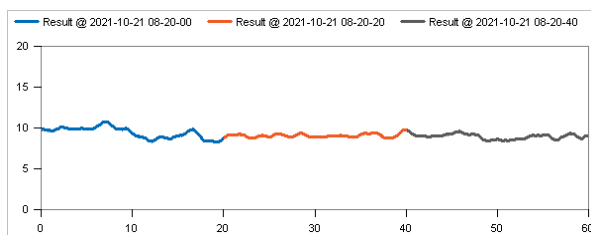

Interval saving - The X0 position is increased at each interval

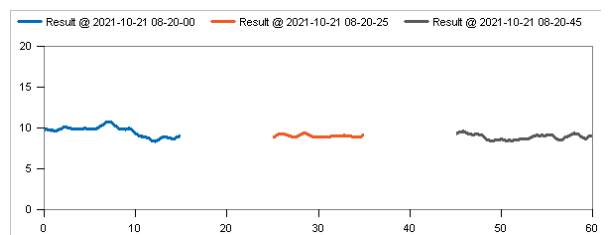

Suspend/Resume data storage -The X0 position is increased upon each resumption



### Compatibility: Data storage - "Continuous numbering" eliminated

Previously, you could use the option: "*Path naming*" to set whether data storage is performed either with a "*time stamp*" or "*Continuous numbering*". This selection is now omitted.

By means of the option "*Storage location measurement data*" (previously: "*Measurement Storage Area*") you can design any desired setup of how to save your measured data. However, as of now, data storage to the device only supports the time stamp option.

Note the following if you load experiments having the setting "Continuous numbering" from Version 5.2 or older:

No information is posted to indicate that this setting is no longer used. The selection is still set to "Continuous numbering"

- When saving to the PC: Data storage with time stamp is used automatically. No special notes to observe in this case.
- When saving to the device: At this time, data storage is performed with "Continuous numbering". Therefore, please set the parameter manually. In future, this will no longer be supported or tested.

In the new view, this parameter is no longer displayed. However, if you use an existing database, the parameter remains visible as long as you continue to use your views.

If you use the new views and wish to correct the setting, you can still insert the parameter in the top device table and modify it there.

### Compatibility: Data storage - Measurement number has been eliminated

The measurement folder generated no longer is assigned the so-called "Measurement number" (example: "2020-03-31 10-00-00 (1)"). This number had served to indicate when device settings had been changed, and this when the measurement had to be "re-prepared".

Since there are now substantially more ways to make changes to the experiment, the "device" is no longer the only determining feature which indicates to which series a measurement belongs. For this reason, the number is no longer stated.

If you wish to generate a measurement number, use the option "*Storage location measurement data*" (previously: "*Measurement Storage Area*"). Here, you can specify your own counter variable which you can iterate either upward or downward at suitable locations.

### Compatibility: Data storage - "Circular buffer memory in the file" and limitation of "saved events" has been eliminated

The new data format doesn't support circular buffer memory and not a limitation of the number of saved events for the data storage. If this is active in your experiments, you are notified accordingly upon loading, indicating that this setting is no longer effective.

Please set the parameter "*Circular buffer time (PC)*" to "*Unlimited*" and "*Saved events (PC)*" to "*all*". If you use the new views, these parameters are hidden. In this case temporarily add the column to the table by means of the "*Column chooser*".



### Compatibility: Data storage - Equal treatment of "Save trigger events in individual files"

Behavior when the option: "*Save trigger events in individual files*" is activated: The measured data are saved separately in individual subfolders. The names of the subfolders correspond to the respective assigned trigger names. This now also applies to the "*immediate trigger*" (Start-trigger without any defined source). Previously, all channels associated with a "immediate trigger" were saved together in the folder "*BaseTrigger*" [previously designated "*Trigger\_48*"] when saving data to the PC.



### Compatibility: Channel type designations

Due to changes to the [channel type designations](#)<sup>78</sup>, some modifications may become necessary if these parameters are used as the target of a "Parameter set import". If you have defined any custom assignment instructions which do not use a "Connection" or "Name", but rather the "Channel type": e.g. all "Counter inputs", then please modify the instruction and if necessary also the existing parameter sets.

The following channel type designations have been modified:

Old term	New term
Field bus: Analog inputs	Fieldbus: Analog inputs
Digital inputs/ outputs (ports)	Digital inputs / outputs (ports)
Field bus: Digital inputs / outputs (ports)	Fieldbus: Digital inputs (ports)
Field bus: Digital inputs / outputs (bits)	Fieldbus: Digital inputs (bits)
Counter inputs	Incremental counter inputs
Monitor: Counter inputs	Monitor: Incremental counter inputs
Display variables	Display variables
Net bits	Ethernet bits

## 2.4.7 imc Online FAMOS and imc Inline FAMOS



### Initialize variables

Whether with- or without Control Commands, variables can now always be created identically: whether "a = 1" or "a = 1".

In simple applications without control commands, it is no longer necessary to place an underline before single-value variables.

And if the application becomes more complex over the course of developments, the control commands can be activated. Advantage: the variable-syntax remains the same and thus also the spelling and sorting order in the Channels list.

### Editor – Autocomplete can be switched on/off

Via the context menu in the Editor, it is possible to activate/deactivate the Autocomplete function.

### Function: FFTAverage

For the "Overlapping", the values 33.33% and 66.66% are now also available.



### Channels originating in different time zones

In imc Inline FAMOS, it is possible to apply calculation operations to combinations of channels even from different devices located in different time zones (as long as these channels are assigned to "BaseTrigger" [previously designated "Trigger\_48"]).

## 2.4.8 Inline Analysis - imc WAVE

The channel-based calculations familiar from imc WAVE are now also available in imc STUDIO.

The Inline Analyses "**imc WAVE Noise**", "**imc WAVE Vibration**" and "**imc WAVE Rotation**" offer numerous capabilities for spectral examinations in the fields of **acoustics**, **vibration analysis** and **order-tracking analysis**. What this means is taking signals measured over the time domain, typically generated by microphones and accelerometers, and performing spectral frequency analyses, such as Fast Fourier Transformation or 1/3- and octave spectrum analysis, on them in real time. For this purpose, a comprehensive variety of settings options are available in order to allow parameterization of the analyses according to established standards. This includes time- and frequency-weighting with standard procedures and filters, window functions, etc.

The Inline Analysis "**imc WAVE Structure**" offers functions for 2 channel **spectrum analysis**, e.g. frequency response function or coherence.

With the corresponding license, you are able to activate the following analyzers:

Name and license required	Description
imc WAVE Noise	Functions for noise analysis, e.g. sound pressure level, Leq, sound intensity, FFT-spectra, 1/3-octave and 1/1-octave spectrum. <ul style="list-style-type: none"> <li>• Sound level meter Standard IEC 61672-1</li> <li>• 1/3- and 1/1-octave analysis as 3D or averaged Standard IEC 61260-1</li> <li>• FFT analysis as 3D or averaged</li> <li>• Determining the sound intensity (time plot, narrow band spectrum and 1/3-octave spectrum) for measurements with an intensity probe</li> </ul>
imc WAVE Rotation	Functions for analysis of rotating machinery <ul style="list-style-type: none"> <li>• Resampling of time-domain channels</li> <li>• Order-tracking analysis as a 3D or averaged</li> <li>• FFT analysis as a 3D or averaged</li> <li>• Calculation of an input signal over time to a channel over RPMs (RPM-presentation)</li> <li>• Calculation of spectrum over time or revolutions, to a 3D-channel over RPMs (RPM-vector-presentation)</li> <li>• Calculation of 3D cross sections</li> </ul>
imc WAVE Vibration	Functions for vibration analysis of human vibration and machine diagnostics <ul style="list-style-type: none"> <li>• Filters (LP, HP, BP, BS, simple/double integration, simple/double differentiation, envelope curve)</li> <li>• Machine diagnostics standard ISO 10816 and ISO 20816</li> <li>• Human vibration filters standard ISO 2631-1, ISO 8041, DIN EN 12299</li> <li>• 1/3- and 1/1-octave analysis of vibration as 3D or averaged Standard IEC 61260-1</li> <li>• FFT analysis as 3D or averaged</li> </ul>
imc WAVE Structure	Functions for 2-channel analysis in the frequency domain <ul style="list-style-type: none"> <li>• Generation of output signals for the purpose of subsequent modal analysis</li> <li>• Calculation of transfer functions with noisy input- and/or output signals</li> <li>• Calculation of the coherence as a quality indicator</li> <li>• Power rating by means of the cross-power-spectrum and spectral power density</li> <li>• FFT analysis as 3D or averaged</li> </ul>

Using the "Inline Analysis"-dialog, you can calculate/derive additional channels from a measured channel.

**Setup page:** Analog channels

**Dialog:** Inline Analysis

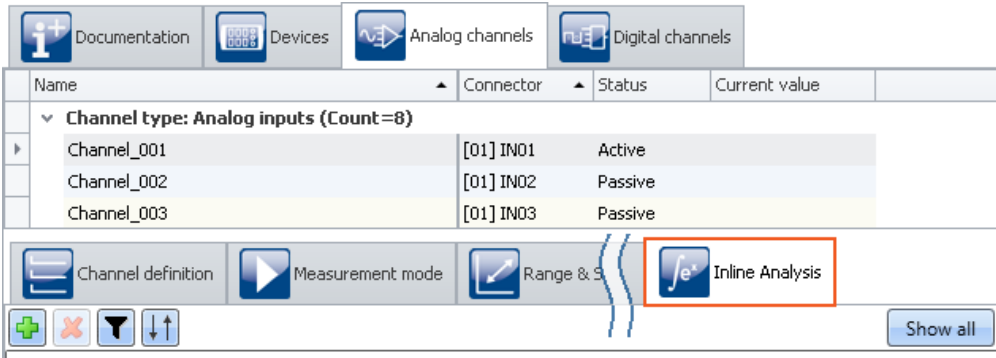

Here you can activate and parameterize Inline Functions specific to individual channels.

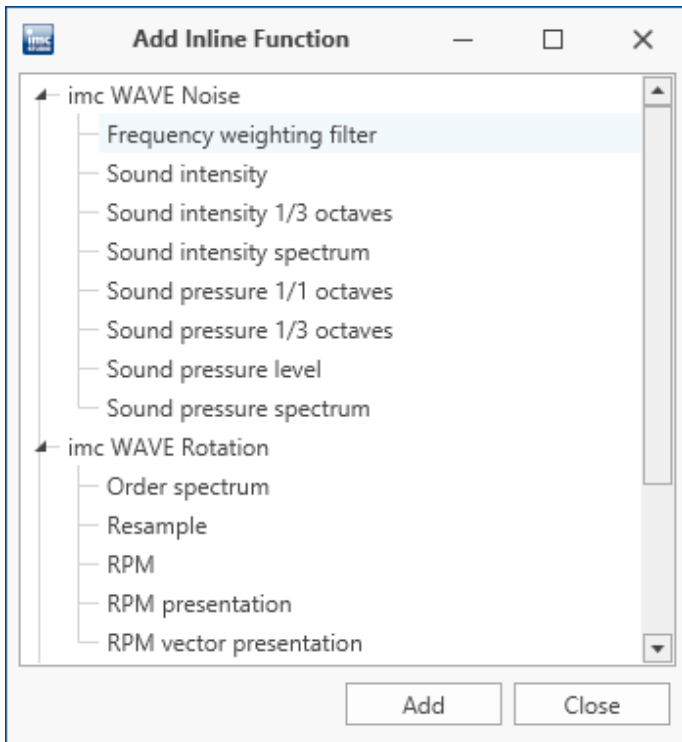

*Adding a new Inline Functions*

## 2.4.9 Panel, Widgets and Data Browser



### "Execute menu action" Widget - Larger icons

The menu ribbon icons are displayed according to scale in the Widget "Execute menu action". This means the icons adjust their size to the Widget's size. This makes these icons easier to recognize. The icons adjust their size while retaining high resolution; the old ones only were stretched out.



"Execute menu action" Widgets



### Curve window - Level indicator

The level indicator now features a three-level color display.

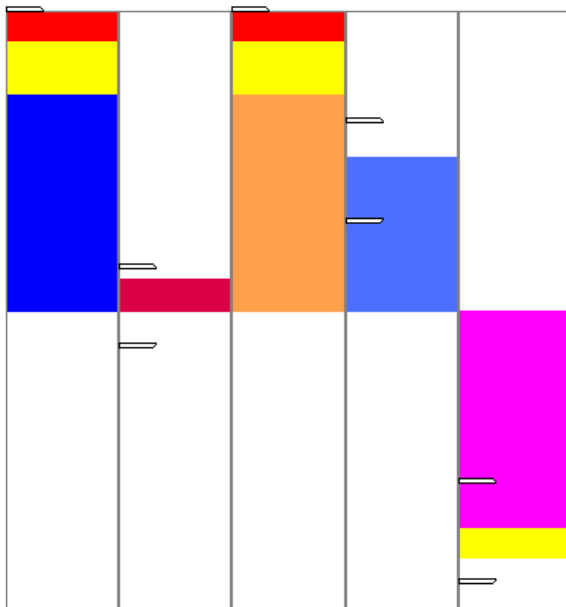

Level indicator with five channels



### Float-variable on the DIO-Widget

The DIO-Widget is implemented as the preferred choice for the device's DIO-ports and Integer pv-variables. Float-variables can also be displayed. The handling for the Float-variables has been improved.

1. pv-Float - The bit count has been limited to 22 bits.
2. If the Widget is linked with Float variables, then boundary violation symbols are displayed if the number is either too small or too large for 22 bits.



### Inserting Widget - Commonly used Widgets

When you drag a variable to the Panel, a choice of Widgets is offered. The list is automatically modified according to your previous selection. Widgets which you had recently inserted frequently have priority among the choices available.

In the subgroups, all Widgets are available for selection, as accustomed.



### Data Browser - Transfer to imc FAMOS

You can conveniently transfer the variables/measurements selected to imc FAMOS by means of the context menu, and analyze and evaluate the channels measured there.



### Data Browser - Event time

When a measurement has multiple different channel starting times (event times), one entry for each different event time appears in the column "*Event time*". The selection is available if the individual channels' **start times** are **different**. For instance, this is the case when in a triggered measurement the individual channels are triggered in succession by different events.

#### Display All

The selection list now provides a new entry: "*All available*". This entry is selected by default. It causes all channels and their associated events to be displayed, even if these were started at different points in time.

Exception: "*Save trigger events in individual files*". In this case, only the channel of the first applicable event is displayed.

#### Extended relationships

When a defined event is selected, the system will make every attempt to display as many channels as possible. What is new is that all channels which have any time overlap are displayed.

Example: One channel starts at 14:00 and ends at 15:00.

**New behavior:** If this channel's event time is selected, all channels are displayed which have measured data from the time between 14:00 and 15:00.

**Old behavior:** When this event time is selected, all channels are displayed which have any measured data at the point in time 14:00, no matter when the channel ends.

Exception: "*Save trigger events in individual files*". In this case, only the channel of the first applicable event is displayed.





Example

Event time

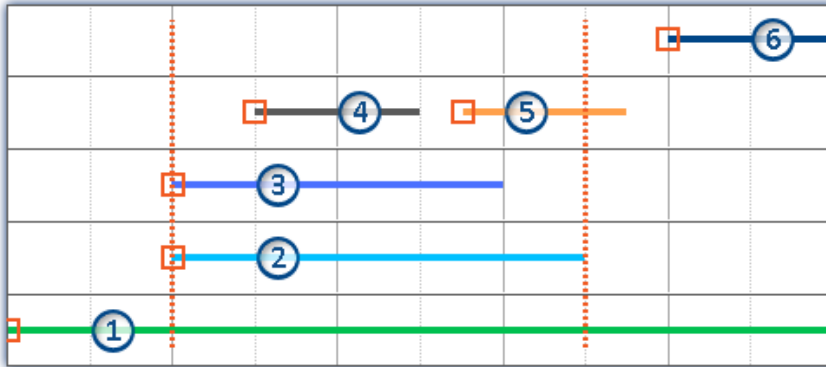

Dotted lines: Start and stop-times of channel 2; e.g. 14:00 and 15:00 from the above example

5 channels are recorded. Counting from the bottom to the top:

- Event 1: The first channel is associated with "BaseTrigger" (Start-button).
- Events 2 and 3: The second and third channel are associated with the same trigger (e.g. "Trigger\_01"). This generates one event time.
- Events 4 and 5: The fourth channel has two events. This generates 2 event times when "Save trigger events in individual files" is activated. Otherwise, only one event time.
- Event 6: The fifth channel is triggered once measurement has concluded on all other triggered channels (except the first channel).

Thus, the Events list shows either 4 or 5 event times, depending on the setting applicable for "Save trigger events in individual files".

In accordance with the respective selection, the individual channels are loaded and displayed.

**New behavior:** The second event time is selected (Channels 2 and 3). The time frame of the longest channel associated with the event is used for selecting the other channels (2). All channels for which there are measured data within this time frame are displayed (1, 2, 3, 4 and possibly 5, depending).

Channel 5 is displayed when "Save trigger events in individual files" is not activated. If this option is activated, then only one event channel can ever be displayed at a time. In that case, only the first channel is displayed (4).

**Old behavior:** All channels which contain values at the event time are displayed (1, 2, 3).



Data Browser - Miscellaneous

- [Measurements can be viewed](#) <sup>80</sup> without previous loading
- [Automatic loading on demand](#) <sup>80</sup> - Only whatever is required is loaded

The following functions are no longer supported:

- "Filter list" in the Data Browser. You are still able to assemble a filter.
- "Navigation mode" in the Data Browser. Navigating by button through the measurement or event is no longer possible. You are still able to select any measurement using the mouse and keyboard.
- "Shows comparison measurement" in the Data Browser. The function is currently hidden.



### Adapt Panel page to window size (keep Widget size)

New function: The Panel page adapts to the size of the currently available space by only adjusting the page size. This is like when you adjust either the right or the bottom page margin.

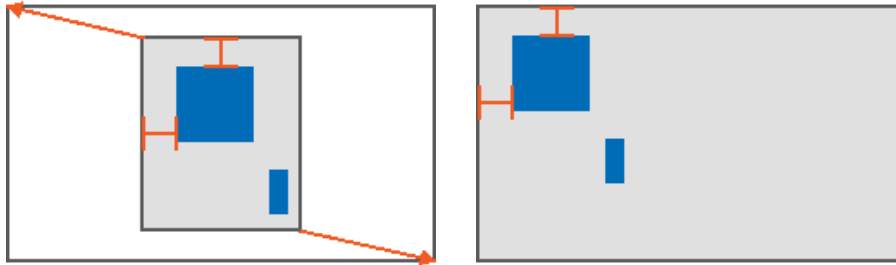

Result

The sizes of the individual Widgets thus remain intact.



### Discontinued: "Audio-Widget"

The following Widget is no longer supported: "Audio-Widget". It was only needed for the channel type "[Audio-Report channel](#)" which was also discontinued.

If you load an experiment belonging to the predecessor version which contains a Widget, the Widget is displayed empty and the corresponding message is displayed.

## 2.4.10 Variables



### Display of user name and role on Report-pages

New system variables are available: User name ("*Name*") and user role "*Role*". By means of these variables, you are able to have the user who is logged in automatically indicated in the Report.



### New variables for measurement status, connection status and synchronization status

New system variables are available:

Device system variable	Description
Measurement status	<p>Returns the state of the measurement: measurement running (1), measurement stopped (0), unclear (-1)</p> <ul style="list-style-type: none"> <li>• 1: Measurement running applies when <b>at least one device</b> is performing a measurement</li> <li>• 0: Measurement stopped applies when <b>all devices</b> are known not to be performing measurement</li> <li>• -1: Unclear applies when <b>at least one device</b> is not connected, and <b>no connected device</b> is running</li> </ul>
Synchronization status	<p>Returns the device's synchronization status: Synchronized (1), not synchronized (0)</p> <ul style="list-style-type: none"> <li>• 1: Synchronized, when <b>all devices</b> are synchronized</li> <li>• 0: Not synchronized, when <b>at least one device</b> is not synchronized</li> </ul> <p>Devices which are not intended to be synchronized are not included in the status check.</p>
Connection status	<p>Returns the status of the device's connection with imc STUDIO: connected (1), not connected (0)</p> <ul style="list-style-type: none"> <li>• 1: Connected, when <b>all devices</b> are connected</li> <li>• 0: Not connected when <b>at least one device</b> is not connected</li> </ul>



## Custom variables created in custom main category

When you create a variable having no category, it is automatically placed among the "*User-defined variables*". When you create a variable having a category, this category is no longer created under "*User-defined variables*", but instead in parallel with it. This allows you to create your own custom folder structures.

If you wish to create a category within the category "*User-defined variables*", you can still do so. Just write a "\" before the category name.

### Example

Category: "MeasurementPoint\_1". A category called "MeasurementPoint\_1" is created in **parallel with** the other categories, such as "*Analog Inputs*". It contains the variable.

Category "\"MeasurementPoint\_1". This creates a category "MeasurementPoint\_1" **within the category** "*User-defined variables*". It contains the variable.

This applies, for example, to variables created by means of the command: "*Load variable*" or to generating a user-defined variable by means of the Data Browser.



## Category-editing - No category

Category editing for user-defined variables and imported variables has been revised.

- The state "*No category*" no longer exists. Anything which previously had "*no category*" is now "*user-defined*".
- The internal identifier "\_\_USER\_\_" is no longer used for identifying the "*user-defined variables*".
- You are able to create variables outside of the category "*user-defined variables*".

### Compatibility:

- Configured commands work in the same way as previously. Here, you will not need to make any changes.  
The exception are commands which have loaded variables previously created under "*no category*". The variables are now created under "*User-defined variables*".
- If you are accessing the internal identifier "\_\_USER\_\_" in any form (e.g. with imc FAMOS), please make modifications accordingly.



### Compatibility: "Data table" - variable type no longer supported

User-defined variables of the type "*Data table*" can no longer be created. When an experiment having such a variable is loaded, a corresponding message is posted in the logbook. The variable is no longer present in the experiment. These variables had been needed for the [SQL-command](#)<sup>104</sup>.

### Compatibility: "Channel" - variable type no longer supported

User-defined variables of the type "*Channel*" can no longer be created. When an experiment having such a variable is loaded, a corresponding message is posted in the logbook. The variable is no longer present in the experiment.

These variables are no longer needed for initialization since variables can now be created and replaced using "*Load Variable*".

### Compatibility: Audio-Report channel - variable type no longer supported

User-defined variables of the type "*Audio-Reportkanal*" can no longer be used. The [Audio-Widget](#)<sup>98</sup> and the [Audio-commands](#)<sup>104</sup> have been eliminated. When an experiment having such a variable is loaded, a corresponding message is posted in the logbook.

The variable type "*Text-Report channel*" is not affected.

## 2.4.11 Import and export - Variable, measurement, parameter set



### Replacing variables from files has been simplified

You now have the ability to **create** new variables and **replace** existing variables in the **same action**. Existing variables could previously only be overwritten using "*Import Variables*", and new variables could only be created using "*Load Variables*". These two actions have been combined.

- Now you can use the action "*Load variable*" to either create new variables from a file or to overwrite existing ones. When you overwrite, all properties of the target variable are also overwritten.
- The action "*Import Variable*" has been renamed to "*Refill variable*": With this action, you are still able to fill existing variables with new values without changing their properties.

Both actions are available in the Data Browser and as a command.



### Note

### Background information

A function "Load Variable" is now implemented, which resembles "Load Data" in imc FAMOS. Therefore in contrast to Version 5.2, in the new version it is permitted to overwrite existing variables. A confirmation prompt appears for each conflict of variables. If any of the confirmation prompts is canceled, the entire import automatically cancels. In this way, the system prevents the loading of an incomplete set of controller parameters, for example.

When an existing variable is overwritten in the process of loading, then it is effectively completely replaced, including all of its properties. In consequence, the old variable is neither deleted nor is any new one created, so that no "events" are triggered by the deletion or creation. This is important for scripts, curve windows, etc.

In contrast to imc FAMOS, there are variables which cannot be overwritten, e.g. channels or pv-variables. The reason is that, for instance, these variables belong to the specific device, or possess specific data formats and other properties which must be retained. If the user attempts to overwrite them, an error message is posted indicating that they can't be overwritten.

It is also not allowed to overwrite any user-defined variables whose validity range is not "temporary". These variables are assumed to have been explicitly created as having a certain data type, which must be retained. The validity range as well must be retained. Temporary user-defined variables, by contrast, are similarly volatile to data returned by imc FAMOS-sequences. For this reason, they may be overwritten by "Load Variable" and can thus, under some circumstances, take a completely different type, etc.

With the "Load Variable" command, there is an option for determining whether existing variables can be overwritten with or without a confirmation prompt. By default, this option is activated, meaning that there is no confirmation prompt for overwriting.

By using "Refill Variable", it is possible to change the content of existing variables. This resembles "Import Variable" in version 5.2. In this way it is possible, for instance, to change the content of pv-variables or user-defined variables. Since this only changes the variables' content and not their type, the target variable and the variable to be loaded must have the same properties, including, for example, the unit. This is managed more strictly than in 5.2; thus, only values and the sample count may be different. Therefore, please always use "Load Variable" in cases where changes are possible.



### "Load Variable" - Loading into a saved measurement

When a variable was loaded from a file to a saved measurement, the variable is copied as a file to the measurement folder. The variable is now also available after loading the measurement.

The following components are affected: Command: Load Variable, loading by means of the Data Browser.



### Menu action: "Save current data" now is equivalent to a full-featured measurement (previously "Save current measurement data")

#### Saved measurement data are secure

Any measured data which are already saved can no longer be overwritten by the menu action "Save current data". If a repeat attempt is made to perform "Save" to an existing file, the system refuses to perform this action. It is also not possible to perform in conjunction with measured data belonging to a continually saved measurement.

#### Compatibility: Only the dat-format remaining

This action only saves data in dat-format now. It does not adopt the formats which are set in the Options for the action "Export current data". Conversion of the measured data to other formats is possible by means of "Export current data" or by means of the imc Format Converter. This provides a clear separation between "Measurement" and "Export" in the Options.



### Compatibility: Export Variable: imc's custom csv-format no longer supported for variables

The imc custom csv-format has been removed, which contained a csv with a specified link to a Raw/Dat-file. In the command "Export Variables", this format was denoted by "\*.csv".

When an experiment having an existing csv-exporter is loaded, a corresponding message is posted in the Logbook. As a precaution, the export type is converted to "dat". Please correct this selection later if appropriate, for instance to a different csv-format.

The following components are affected: Command: Export Variable, export via the Data Browser, options for "Export current Data".

Note: "Export parameter set" (e.g. export of the device configuration as a parameter set) is possible in this format without any restrictions.

### Compatibility: Export parameter set: XML format no longer supported

The XML format has been eliminated.

When an experiment having an existing xml-exporter is loaded, a corresponding message is posted in the Logbook. As a precaution, the export type is converted to "csv". Please correct this selection later if appropriate, for instance to a different format.

### Compatibility: Export parameter set: User-defined text-variables can not be exported as a parameter set

For **exporting variables' values**, instead of the command: "Export parameters", the command "Export variable" should be used. This command is specially designed for variable values. User-defined text variables can no longer be exported using the command: "Export parameters".

## 2.4.12 Sequencer and commands



### Command "Delete Variable" revised

Variables can be deleted from any category: Previously the command could only delete variables belonging to the category "User-defined". Since user-defined variables can now be created in their own categories, this limitation no longer applies.

The option "Treat error as warning" has been eliminated. Now a warning is categorically issued and no longer an error message. If it is not possible to delete a variable upon running, such as device variables and system variables, an appropriate warning is posted.



### Command "Run imc FAMOS sequence" - saving of results modified

When the sequence results are transferred back to imc STUDIO, they can be saved along with an existing measurement. Results which are not saved now land under "Current Measurement", even when a measurement is selected as the target.

To imc FAMOS			From imc FAMOS			Options		
Transfer variable from imc FAMOS								
Storage location (only for saved results):								
Last completed measurement ( LastMeasurement )								
	imc STUDIO variable		imc FAMOS variable		Save			
	Res1	▼	Res1		<input checked="" type="checkbox"/>			
	Res2	▼	Res2		<input type="checkbox"/>			

*Res1 is saved as a file and as a variable in the last completed measurement.*

*Res2 is saved as a temporary variable under "Current Measurement".*



### Compatibility: Command "Run imc FAMOS Sequence" - return values

As the target variable in imc STUDIO, an appropriate data type is now expected. A channel can no longer be transferred to a "User-defined Variable" of the type "Numeric" (Single Value). Previously the system assumed that the last value would be the one to expect. But it could also be an error in the implementation. Now a message is posted to indicate when the data type is not appropriate.

Please modify the type in imc FAMOS if you wish to obtain a single value. If you need a channel, use as the target a variable created by imc FAMOS. This will then always be assigned the appropriate data type.

### Compatibility: Command "Run imc FAMOS Sequence" - Only the dat-format remaining

This command only saves data in dat-format now. It does not adopt the formats which are set in the Options for the action "Export current data".



### Compatibility: A variable can no longer possible be deleted using the command "Set variable"

The option/column "Delete" is no longer available. As previously recommended in the user's manual, for such a case the command "Delete Variable" is to be used.

When you load an experiment created in the predecessor version, in which the delete function was performed, a corresponding entry is made in the logbook. This entry records the variables which had been deleted by means of the command.

**Alternative solution:** You can add the command "Delete Variable" at the corresponding location. The existing command "Set Variable" no longer contains the variables to be deleted.



### Discontinued: "SQL-Command"

The following command is no longer supported: "SQL-Command". It no longer meets the current requirements of SQL-communication.

When you load an experiment created in the predecessor version which contains an SQL-command, a corresponding message appears in the logbook. An "empty" command as a placeholder is inserted into the sequence where you use the command, in order to indicate the location.

**Alternative solution:** In such a case, please use the imc FAMOS Database Kit or the component Scripting in order to incorporate a custom solution (license required).

### Discontinued: "Playback audio channel" and "Record audio channel"

The following commands are no longer supported: "Playback audio channel" and "Record audio channel". They were only needed for the equally discontinued channel type "[Audio-Report channel](#)".

When you load an experiment belonging to the predecessor version which contains either of these commands, a corresponding error message appears in the logbook. In the sequence in which you use one of these commands, an "empty" command is inserted as a placeholder in order to mark its position.

## 2.4.13 Events



### New events for the measurement management

There are now new Events which are triggered upon changes to the measurements in the Data Browser.

- Upon conclusion of a measurement (or of an interval), the "MeasurementFolder\_Closed"-event is triggered.
- When a new measurement appears in the Data Browser, the "MeasurementFolder\_New"-event is triggered.
- When a measurement is deleted, the "MeasurementFolder\_Deleted"-event is triggered.
- When the measurement is updated, the "MeasurementFolder\_Updated"-event is triggered.

**Compatibility:** The event "Storage\_DirectoryUpdate" is no longer supported. It has been replaced with "MeasurementFolder\_Closed". Any appended commands are automatically moved accordingly. Please save the automatic change. A corresponding message is posted in the logbook.



### User-defined events: Initialization / first value no longer counts as a change

There can only be a change to a trigger, variable or channel if a previous value had already been present. Thus for instance, if during the "Prepare" process for a measurement, a trigger's status changes from "not defined" to "not released", this is not a change. In consequence, no event will be triggered in this case.

This also applies if the event is defined as "Channel < 5". If the channel's value is < 5 already at the beginning of the measurement, the event is not triggered. This had already been the system's behavior previously, if for instance at the end of the first measurement the channel's value was already < 5.

If you wish to apply the condition at the start of the measurement, then link the event to an appropriate trigger (AND conjunction), for example.





## Events have been enhanced with the functions: "Stop on error" and "De-/activation"

In the Sequencer-sequence, you are able to activate/deactivate individual commands. Additionally, you are able to make a setting there which governs whether the sequence should be interrupted if an error occurs.

This is now also possible for event-sequences. You are able to deactivate complete events along with their commands, or only individual commands.

Example: A Timer-event is intended to start only once its configuration has been completed. Now you can deactivate it and re-activate it at the desired moment in time.

Link events with commands					Enable	Stop on error
Status	Name	Comment				
▼	Button1					
▼	Clicked	Occurs when the ...		<input checked="" type="checkbox"/>	<input checked="" type="checkbox"/>	
	#01 Run imc FAMOS sequence: ...			<input checked="" type="checkbox"/>	<input checked="" type="checkbox"/>	
	#02 Export parameters			<input checked="" type="checkbox"/>	<input checked="" type="checkbox"/>	
	#03 Show Panel page as dialog:			<input checked="" type="checkbox"/>	<input checked="" type="checkbox"/>	
	#04 Export Panel page			<input checked="" type="checkbox"/>	<input checked="" type="checkbox"/>	

Commands associated with a button's event

Status	Name	Comment	Enable	Stop on error
▶	Panel	Experiment-specific events of the Panel		
▼	Page 1	Experiment-specific events of the Panel		
▼	Button1	Experiment-specific events of the Panel		
▼	Clicked	Occurs when the button has been clicked.	<input checked="" type="checkbox"/>	<input checked="" type="checkbox"/>
	#01 Run imc FAMOS sequence ...		<input checked="" type="checkbox"/>	<input checked="" type="checkbox"/>
	#02 Export parameters		<input checked="" type="checkbox"/>	<input checked="" type="checkbox"/>
	#03 Show Panel page as dialog:		<input checked="" type="checkbox"/>	<input checked="" type="checkbox"/>
	#04 Save Panel page as PDF		<input checked="" type="checkbox"/>	<input checked="" type="checkbox"/>
>	Project	Project-specific events		
▼	Sequencer	Experiment-specific events of the Sequencer		
	Device_AfterCheckConfiguration	After checking the configuration of a device	<input checked="" type="checkbox"/>	<input checked="" type="checkbox"/>
	Device_AfterRequestConnect	After trying to connect to a device	<input checked="" type="checkbox"/>	<input checked="" type="checkbox"/>
	Device_AfterRequestDisconnect	After trying to disconnect from a device	<input checked="" type="checkbox"/>	<input checked="" type="checkbox"/>
▼	Device_BeforeCheckConfiguration	Before checking the configuration of a device	<input checked="" type="checkbox"/>	<input checked="" type="checkbox"/>
	#01 Import variable		<input checked="" type="checkbox"/>	<input checked="" type="checkbox"/>
	Device_BeforeCreateDiskStart		<input checked="" type="checkbox"/>	<input checked="" type="checkbox"/>

Commands in the Sequencer associated with the events

1: Applies to the respective command

2: Deactivation applies to all commands associated with the event

If the option is deactivated for the event, this applies to all associated commands. If the option is activated for the event, the setting applied to the respective command.

**Compatibility:** Converted experiments from older versions work as familiar from previously. Previously, the event-sequences did not halt upon appearance of errors. In consequence, with existing experiments the checkmark for "Stop on error" is not set automatically.

### 2.4.14 Scripting / API



#### .NET Framework 4.8

The Target-Framework ".NET Framework 4.8" is now used.



### Measurement management

You can load, unload (close), rename and delete measurements by means of a "MeasurementManagerService".



### Variables

The variable access has changed fundamentally and is done via the `Variables` class (formerly `Datapool` class). Scripts from 32-bit versions of must be adapted by hand.

By means of the Event-Manager, it is possible to respond to changes to variables.

A blockwise writing of variables has been implemented (internally). In Scripting this can be implemented with the help of the `IVariableManagerWriterTask`.



### List-Widget - Editing zones

In Scripting, it is now possible to edit zones of list-Widgets and to supplement these with new entries.



### Compatibility: `imc.Studio.Interfaces.V2.dll`

The `imc.Studio.Interfaces.V2.dll` has been integrated into `imc.Studio.Interfaces.dll` and is thus now omitted. Please modify your scripts accordingly.



### API

In the imc STUDIO API, the actions relating to saving measured data (*Save/Export current data*) were missing from the constants of the "ActionNames".

The Shared-project, and the sample data no longer bear the name "API" but are assigned the version number, e.g. "API 2022".

## 2.4.15 Miscellaneous optimization

Alongside minor bug fixes, the following important improvements have also been implemented:

Area	Description
Widget	<ul style="list-style-type: none"> <li>Table: When something was entered in the property "Text", it was no longer possible to edit the value of a linked variable by means of the entry.</li> <li>Curve window: The property "Operable" is now located among the "Important properties".</li> </ul>
Data Browser	<ul style="list-style-type: none"> <li>When a channel name contained one of the following characters (' and &amp;), it was not possible to load the measurements. Now the characters can be processed correctly.</li> <li>Feedback to the user - If a measurement can not be loaded, for instance because the files are defective, a message is now posted.</li> <li>The context menu function "Update Data Browser" has been eliminated. In imc STUDIO, this function is no longer needed.</li> </ul>
Current value window	<ul style="list-style-type: none"> <li>When a variable is deleted from the Data Browser, it is automatically deleted from the "Current value window".</li> <li>User-defined text variables having a decimal point were interpreted and displayed as a number in the "Current value window".</li> <li>In case of an invalid value entry for a numerical variable, the variable is no longer set to 0 but retains its previous value.</li> </ul>

Area	Description
Commands	<ul style="list-style-type: none"> <li>"Export parameter set / variables": When exporting variables in the csv/dat-format, the unit is included in the export.</li> <li>"Set Variable": Numbers having a comma "," as the separator character for the decimal positions can now be subjected to calculations using the command; e.g. "Displayvar_01 + 0,1". Previously, only a period was possible "Displayvar_01 + 0.1".</li> </ul>
Project management	In the project management dialogs, many small improvements have been implemented which, among other things, provide assistance in operation or feedback about actions. For example, menu items such as "Add experiment template" are only still offered if they are also activated. The Import-button would be displayed or not depending on the selection. Following import, the experiment was not always selected.
User management and access privileges	There are new access privileges designed to prevent opening the Assistant; e.g. for the imc Online FAMOS Editor, or the CAN-Assistent or the like.
Variables	<ul style="list-style-type: none"> <li>Variables which are created by means of "Load Variable" can now also be edited. Previously, they were always write-protected, so that values could not be changed.</li> <li>After loading/importing of variable, the files were still in use, or blocked. Thus, the files on the hard drive could for instance no longer be overwritten using imc FAMOS. Now imc STUDIO releases the file for editing after the action.</li> </ul>
Save view	When one saved the view on a 4K monitor with adjusted font scaling, the view was subsequently defective for smaller monitors.
imc Online FAMOS and imc Inline FAMOS	Autocomplete in the Editor - you are able to switch the autocomplete on/off via the context menu.
Setup - Export	Setup/Export configuration: With "Export balancing values", the monitor channels were always also included in the export.
Setup - balancing	<p>Taring and bridge balancing action before and during running measurement:</p> <p>Upon starting the next measurement after a bridge balancing action, the level indicator automatically adopts the channel's value range boundaries. If the balancing is performed during the measurement, the Widget does not display the correct value level since it only knows the previous range boundaries. The indicated measurement range in the file also retains the previous state.</p>
fos4X	<p>The light output regulation can be set as the parameter "Supply". This applies to fos4Test Dyn, but no to fos4Test nSens.</p> <p>Integer fixed values between 1 % and 100 % can be specified, or alternatively the built-in automatic regulation can be activated. Upon start of the measurement, for a fixed number, the light output regulation is deactivated and the laser output is set to the value specified. For "auto", the light output regulation is activated.</p>
3rd-party devices	<p>Saving measured data: One sample too many was often saved.</p> <p>Example with the device: "FunctionSimulator": Measurement duration: 10 seconds at 50 Hz resulted in 501 data points. Now the result always has the correct point count.</p>
Measure a user-defined characteristic curve	The command "Measure a user-defined characteristic curve" has been reactivated. Using this command, you can record and save characteristic curves for subsequent use; e.g. by means of automatic import of a supplemental file for the <a href="#">Charact</a> -function in imc Online FAMOS.

Area	Description
Automation	<ul style="list-style-type: none"> <li>• Value limit monitoring - When the sequential order of a boundary limit monitoring was changes, a different value always was returned than the one desired.</li> <li>• imc FAMOS data cutting Saved measurements could be selected as the source. The element in the Automation is not designed for this purpose, since there is no cutting. If the user made this setting, a warning was posted upon loading which indicated that the source will be reset. It is still possible to load individual channels from a measurement by means of @...</li> <li>• Upon encountering an error, the task no longer halts execution of synchronized events (command sequence) but instead continues.</li> </ul>
User-defined events	The behavior in response to the conditions " <i>inside of range</i> " and " <i>outside of range</i> " has been corrected. For " <i>inside</i> ", the range boundaries are now included, and for " <i>outside</i> " they are not.
Guardian and WatchDog	There is a separate Guardian and a separate WatchDog for the 64-bit version. In case of parallel installation with a Version 5 system, two services now run. The 64-bit variant has the suffix "V2".
Options	The options for the RAM-size of curve windows and FIFOs have been eliminated. They are no longer relevant for the 64-bit system.
imc STUDIO API	<ul style="list-style-type: none"> <li>• The acknowledgement in the imc STUDIO API for the method "<i>GetImcStudioInstallPath</i>" in response to incorrect arguments has been improved.</li> <li>• The examples of the imc STUDIO API are now installed in a folder with the imc STUDIO-version number.</li> </ul>
Installation	imc DEVICES - Fieldbus selection: In the selection of components for imc DEVICES, all Fieldbusses are now automatically included in the installation. It is no longer necessary to make a selection. Thus any Fieldbus which is available in the device can always be used.
Documentation	<ul style="list-style-type: none"> <li>• The program "<i>imc Help and Documentation</i>" now also lists the documentation for imc FAMOS (as of Version 2021) and imc Shared Components.</li> </ul>
About-Dialog	The About-dialog has been expanded. It now presents the license texts of the currently opened Open Source components.

## 2.5 Update-notes and compatibility from 5.2 to 2022

If you plan to update from Version 5.2 to 2022, there are a few things which you may need to observe regarding any existing databases. In particular, be aware of the following points:

Area	Function
Discontinued devices	<ul style="list-style-type: none"> <li>• <a href="#">Devices</a> <sup>[85]</sup> belonging to groups 2 and 3</li> <li>• <a href="#">imc Hil</a> <sup>[85]</sup></li> <li>• 3rd-party device: "Agilent"</li> <li>• 3rd-party device "<a href="#">Profinet-Sniffer</a>" <sup>[73]</sup></li> </ul>
Setup	<ul style="list-style-type: none"> <li>• Data storage - <a href="#">Suspend and Resume data storage</a> <sup>[90]</sup>: X0 now is assigned other values</li> <li>• Data storage - "<a href="#">Continuous numbering</a>" <sup>[91]</sup> has been eliminated</li> <li>• Data storage - "<a href="#">Measurement number</a>" <sup>[91]</sup> has been eliminated</li> <li>• Data storage - "<a href="#">Circular buffer memory in the file</a>" <sup>[91]</sup> has been eliminated</li> <li>• <a href="#">Default values</a> <sup>[89]</sup> are saved along with the projects</li> <li>• imc REMOTE SecureAccess is no longer supported</li> <li>• <a href="#">Channel type designations</a> <sup>[92]</sup> have been modified</li> <li>• Old pages having the name "<a href="#">*-Statistics</a>" <sup>[71]</sup> have been eliminated</li> <li>• Channels with reduced data can not be used in imc STUDIO. imc Online FAMOS results of the "TransRec" function and DI-port compressed channels cannot be transferred to the PC.</li> </ul>
Measurement management	<ul style="list-style-type: none"> <li>• <a href="#">Automatic loading on demand</a> <sup>[80]</sup> - Only what is required is loaded.</li> </ul>
Variables	<ul style="list-style-type: none"> <li>• Category processing - "<a href="#">No category</a>" <sup>[99]</sup> no longer exists</li> <li>• User-defined variables: The types "<a href="#">Channel</a>" <sup>[100]</sup>, "<a href="#">Audio-Report channel</a>" <sup>[100]</sup> and "<a href="#">Data table</a>" <sup>[100]</sup> are no longer supported.</li> <li>• Menu action: "<a href="#">Save current data</a>" <sup>[102]</sup> (previously "Save current measurement data"): This action only saves the data in dat-format from now on.</li> <li>• <a href="#">Export Variable</a> <sup>[102]</sup>: The csv-format is no longer supported for variables.</li> <li>• <a href="#">Export parameter set</a> <sup>[102]</sup>: The XML format is no longer supported.</li> <li>• <a href="#">Export parameter set</a> <sup>[102]</sup>: User-defined text-variables can not be exported as a parameter set.</li> <li>• Automatic conversion of the linkages of variables between Widgets and trigger- or system-variables from experiments created in Version 5.0Rx is not possible. Please modify the variable linkages manually.</li> </ul>
Data Browser	<ul style="list-style-type: none"> <li>• "<a href="#">Filter list</a>" <sup>[97]</sup> has been eliminated</li> <li>• "<a href="#">Navigation mode</a>" <sup>[97]</sup> has been eliminated</li> <li>• "<a href="#">Shows comparison measurement</a>" <sup>[97]</sup> has been eliminated</li> </ul>
Widget	<ul style="list-style-type: none"> <li>• The "<a href="#">Audio-Widget</a>" <sup>[98]</sup> are no longer supported</li> </ul>
<a href="#">Widget - Table</a> <sup>[72]</sup>	<ul style="list-style-type: none"> <li>• Interplay between settings for "Factor" and "Decimal places" has been changed.</li> <li>• Decimal place count: "auto" no longer equates to "1".</li> </ul>

Area	Function
Commands	<ul style="list-style-type: none"> <li>• It is no longer possible to delete a variable using the <a href="#">command "Set Variable"</a><sup>[103]</sup>.</li> <li>• Discontinued: "<a href="#">SQL-command</a>"<sup>[104]</sup></li> <li>• The commands: "<a href="#">Playback audio channel</a>"<sup>[104]</sup> and "<a href="#">Record audio channel</a>"<sup>[104]</sup> are no longer supported</li> <li>• The command "<a href="#">Run imc FAMOS sequence</a>"<sup>[103]</sup> - Channel return values can no longer be transferred back to a "User-defined variable" of the type "Numeric" (Single value).</li> <li>• The command "<a href="#">Run imc FAMOS sequence</a>"<sup>[103]</sup> - This command only saves data in dat-format now.</li> </ul>
Events	<ul style="list-style-type: none"> <li>• The event "Storage_DirectoryUpdate" is no longer supported. It has been replaced by "<a href="#">MeasurementFolder Closed</a>"<sup>[104]</sup>.</li> </ul>
Automation	<ul style="list-style-type: none"> <li>• <a href="#">imc FAMOS data cutting</a><sup>[108]</sup>: A saved measurement can not be selected as the source.</li> </ul>
Scripting	<ul style="list-style-type: none"> <li>• <a href="#">imc.Studio.Interfaces.V2.dll</a><sup>[106]</sup> has been integrated into imc.Studio.Interfaces.dll.</li> </ul>
imc STUDIO PowerQuality	imc STUDIO PowerQuality is no longer supported
Options	<p>The option for hiding the measurements in the Data Browser has been moved. It is now located as follows: Options: "Variables" &gt; "Measurement Administration" &gt; "Access to stored measurements"</p> <p>Due to the extra internal separation between the components "Project Management" and the display of the measurements in the Data Browser, the option cannot be ported over when updating from older versions. If you wish not to see any measurements in the Data Browser, deactivate the option again.</p>
3PDI - Function Simulator	The device needs to be de-selected once and then re-selected when you load an experiment from imc STUDIO 5.2.

# Device overview

Some of the capabilities discussed in this document only pertain to certain device models. The associated device groups are indicated at the respective locations. The groups are shown in the following table which can be used with imc STUDIO.

— not available  
 CRXT imc CRONOS-XT      ● standard  
 CRFX imc CRONOSflex      ○ optional  
 CRC imc CRONOScompact

imc device	SPARTAN	BUSDAQ	BUSLOGflex	BUSDAQflex	SPARTAN-R	SPARTAN-N	CRSL-N	CRC-400	CL-N	C-SERIE-N	CL-FD	C-SERIE-FD	CRFX-400	CRFX-2000	CRC-2000G	CRC-400GP	CRFX-2000G	CRFX-2000GP	CRXT	EOS	ARGUSfit
Driver package	imc DEVICES																		imc DEVICEcore		
Firmware group	A																		B		
Device group	A4				A5				A6	A7				B10	B11						
SN <sup>1</sup>	13				14				16	19				4120	416						
TCP/IP Interface [MBit/s]	100				100				100	1000				1000	1000						
Sampl.Rate <sup>2</sup> [kHz]	400				400				2000 / 400 <sup>3</sup>	2000 / 400 <sup>3</sup>	2000 / 400 <sup>3</sup>	2000	2000	2000	4000	5000					
STUDIO Monitor supported	●				●				●	●				—	—						
Connections <sup>4</sup>	4				4				4	4				—	—						
<b>Signal processing in the device</b>																					
Online FAMOS	○	○	—	○	○	●	●	●	●	●	●	●	●	●	●	●	●	●	●	—	●
Preprocessing original channel	●	—	—	—	●	●	●	●	—	●	●	●	—	—	—	—	—	—	—	—	—
Preprocessing monitor channel	●	—	—	—	●	●	●	●	—	●	●	●	—	—	—	—	—	—	—	—	●
<b>Data Storage</b>																					
CF	●				●				—	—				—	—						
Express Card	—				—				●	—				—	—						
CFast	—				—				—	●				—	—						
USB	—				—				●	●	●	●	●	—	—	—	—				
microSD	—				—				—	—				—	●						
Storage on network drive	●				●				●	●				—	—						
Internal hard disk	○	(○) <sup>5</sup>	—	—	○	○	—	—	○	○	○				○	●	—				
<b>Synchronization</b>																					
DCF	●				●				●	●				—	—						
IRIG-B	—	—	●	●	●				●	●				●	●						
GPS	●	●	—	(●) <sup>6</sup>	●				●	●				—	●						
NTP	—	—	●	●	●				●	●				●	●						
PTP	—				—				—	—	●	—	●	●	—	—					
Phase offset correction	—	—	●	●	●				●	●				●	●						

1 Extend serial number range by four digits (three for imc EOS)  
 2 Max. aggregate sampling rate (see data sheet)  
 3 2000 via EtherCAT else 400  
 4 Number of imc STUDIO Monitor-connections or imc REMOTE (as of 14xxxx) connections  
 5 not available for imc BUSDAQ-2  
 6 not available for imc BUSDAQflex-2-S



An Axiometrix Solutions Brand

## Contact imc

### Address

imc Test & Measurement GmbH  
Voltastr. 5  
13355 Berlin

Phone: (Germany): +49 30 467090-0

E-Mail: [info@imc-tm.de](mailto:info@imc-tm.de)

Internet: <https://www.imc-tm.com>

### Tech support

If you have problems or questions, please contact our tech support:

Phone: (Germany): +49 30 467090-26

E-Mail: [hotline@imc-tm.de](mailto:hotline@imc-tm.de)

Internet: <https://www.imc-tm.com/service-training/>

### imc ACADEMY - Training center

The safe handling of measurement devices requires a good knowledge of the system. At our training center, experienced specialists are here to share their knowledge.

E-Mail: [schulung@imc-tm.de](mailto:schulung@imc-tm.de)

Internet: <https://www.imc-tm.com/service-training/imc-academy>

### International partners

You will find the contact person responsible for you in our overview list of imc partners:

Internet: <https://www.imc-tm.com/imc-worldwide/>

### imc @ Social Media

<https://www.facebook.com/imcTestMeasurement>

<https://www.youtube.com/c/imcTestMeasurementGmbH>

[https://twitter.com/imc\\_de](https://twitter.com/imc_de)

<https://www.linkedin.com/company/imc-test-&-measurement-gmbh>